

# METROPOLIST

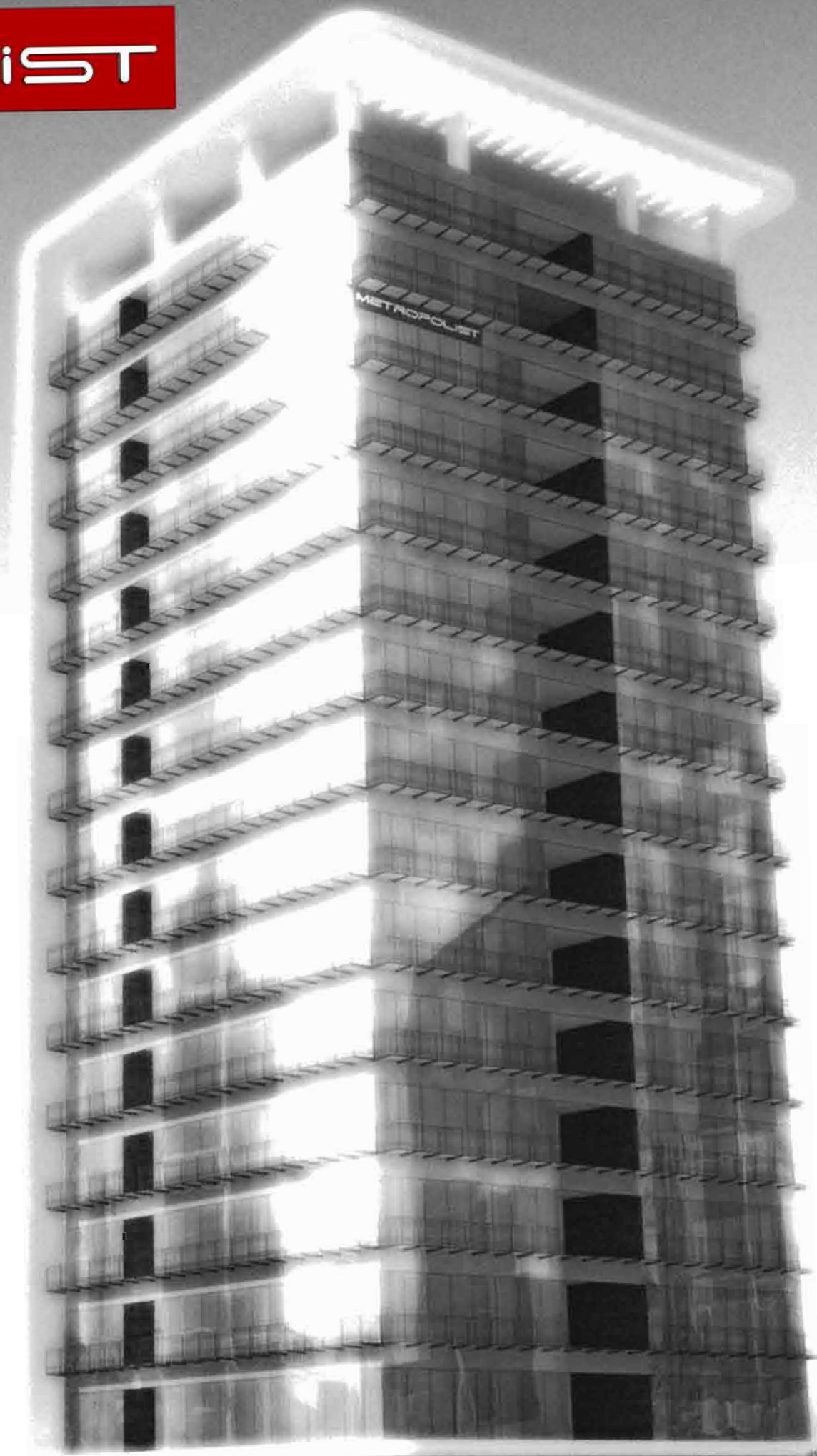



METROPOLIST

## İÇİNDEKİLER

ofis kavramı  
örnek proje:İZPARK  
kat tipleri  
ofis tipleri  
statik önerisi  
iç mimari  
gölgeleme analizi  
detaylar



**OFİS** = OFFICE = OF'IS = OFFICIUM=  
DESTEK, GÖREV, HİZMET



ÜRETİM KAVRAMI OLARAK  
OFİS

primo de februario 1516. Als ich  
Herr Jacob Fugger kam: deherst  
e. Zener 1517. verstorben wurde

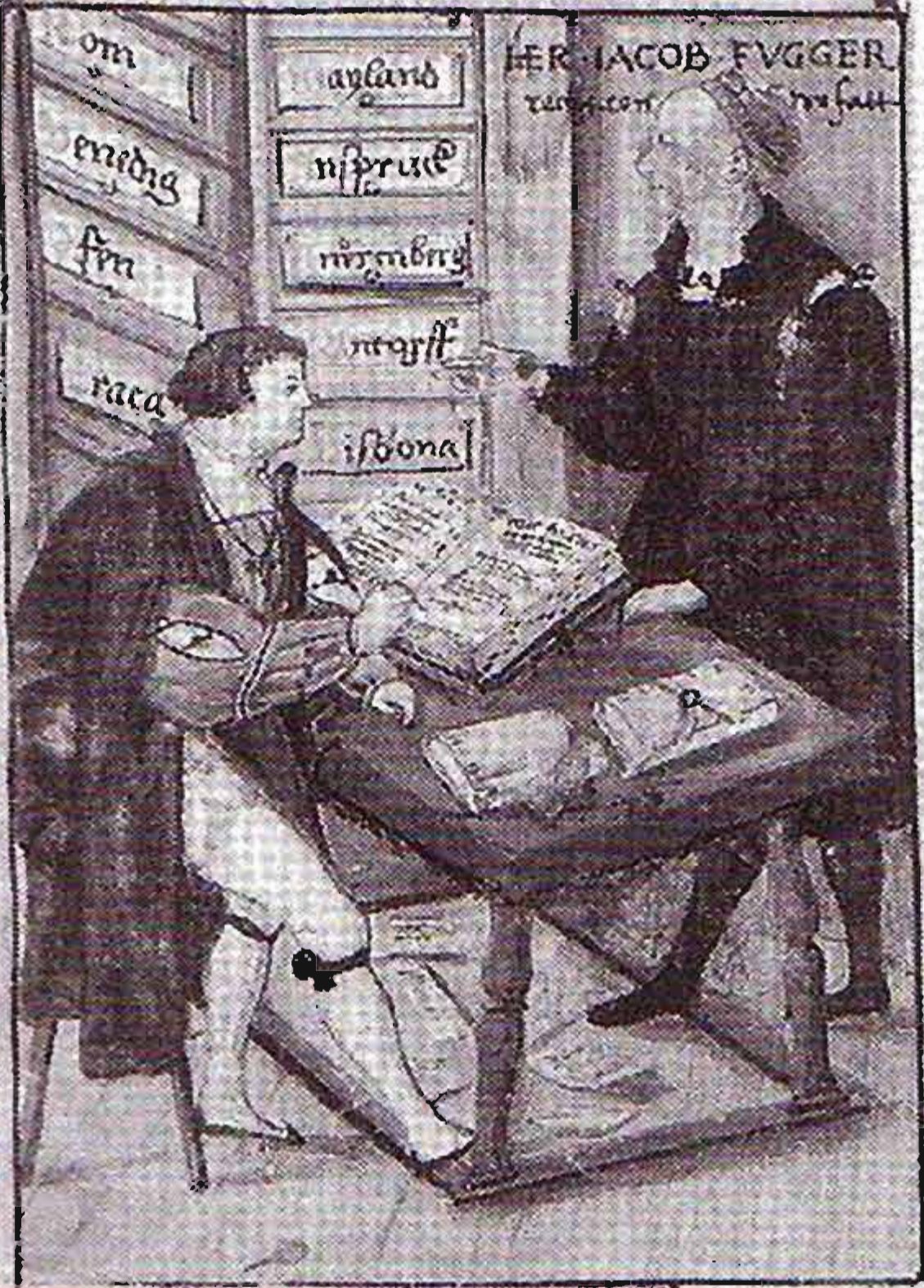

19. iac. d. me. 8. tag

### ZAMAN İÇİNDE

OFİSLERİN KAVRAMSAL VE MEKANSAL GELİŞİMİ



MANASTIR



SARAY



PALAZZO



MARKET



GÜNAH ÇIKARMA  
HÜCRESİ



ÇADIR



FABRİKA



ALAN



## GELECEĐİN OFİSİ..

FİKİRLERİN, ÖNERİLERİN VE TEKLİFLERİN  
TARTIŞILDIĐI, PAYLAŞILDIĐI SOSYAL BİR  
PAZAR YERİ OLMALIDIR.



LABORATUVAR



KOLEJ



KLÜP



VIPSALONU



ALIŞVERİŞ MERKEZİ



KONTROL MERKEZİ



VAHA



KASABA SOKAĞI





## İŞ FONKSİYONLARI

DİREKT

TİCARET

DANIŞMANLIK

UZLAŞMA

KONTROL

YARATICILIK

İLETİŞİM

EYLEMSEL

REHBERLİK

GÖRÜŞME

TAKIM ÇALIŞMASI

YARATICI FİKİR ALIŞVERİŞİ

BİLGİLENDİRME

KONFERANS

ENDİREKT

YÖNETİM

ÖĞRENME

ARAŞTIRMA

KAYNAK SAĞLAMA



İZPARK



İZPARK







GELİŞEN TEKNOLOJİYE RAĞMEN HALA OFİSLERE İHTİYACIMIZ VAR!



KAT PLAN TIPLERİ



METROPOLIST

# KAT TIPLERİ

**DORE**  
ARCHITECTS





METROPOLIST

KAT TIPLERİ

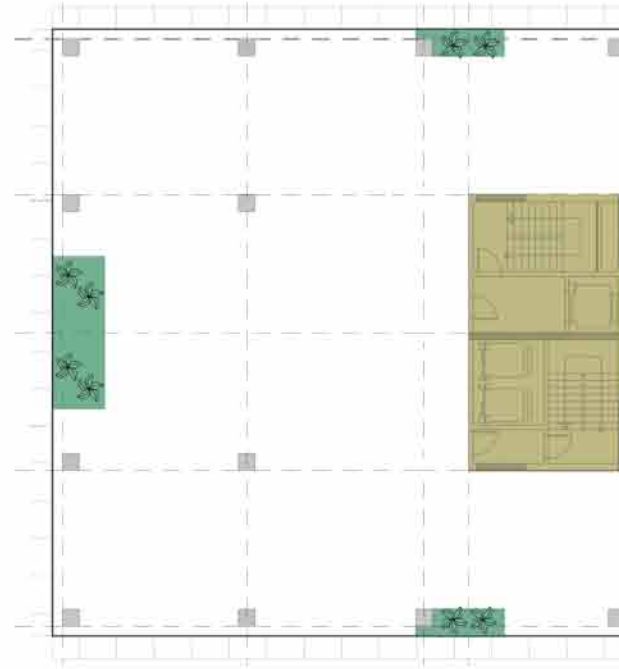

OFIS

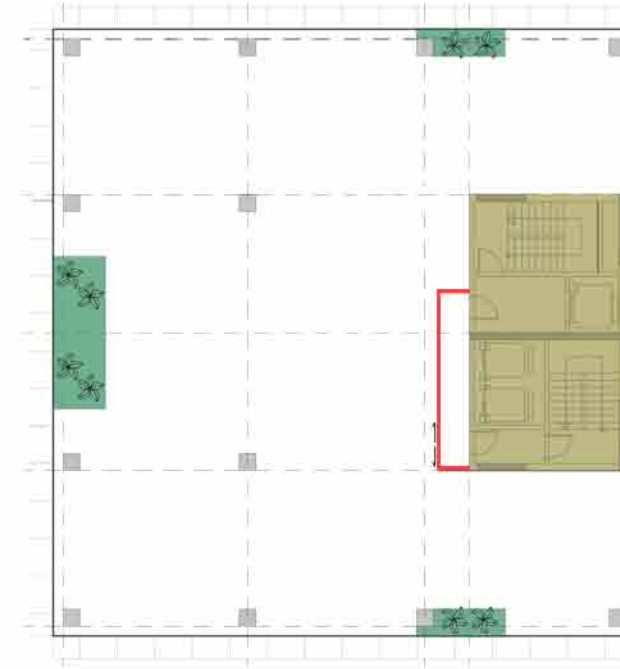

1 OFIS

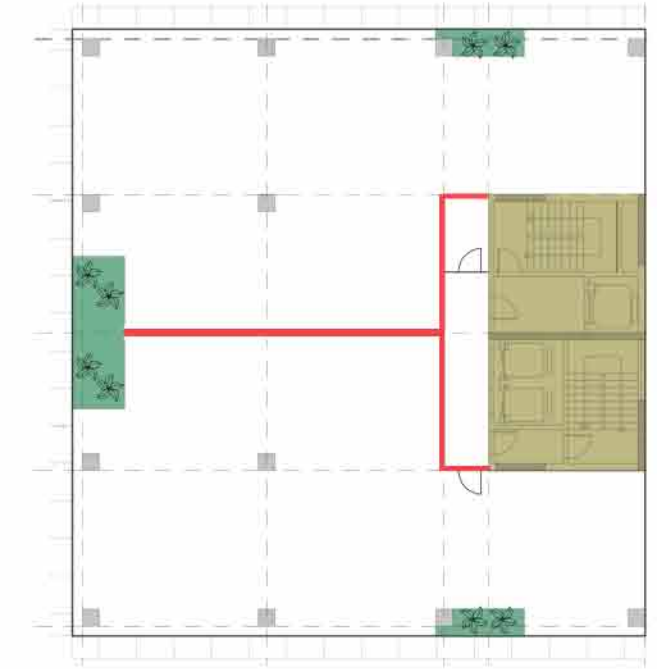

2 OFIS

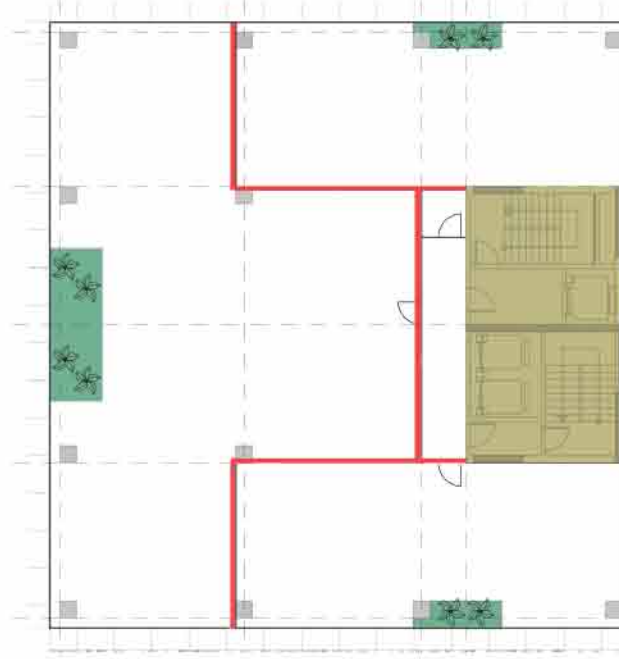

3 OFIS

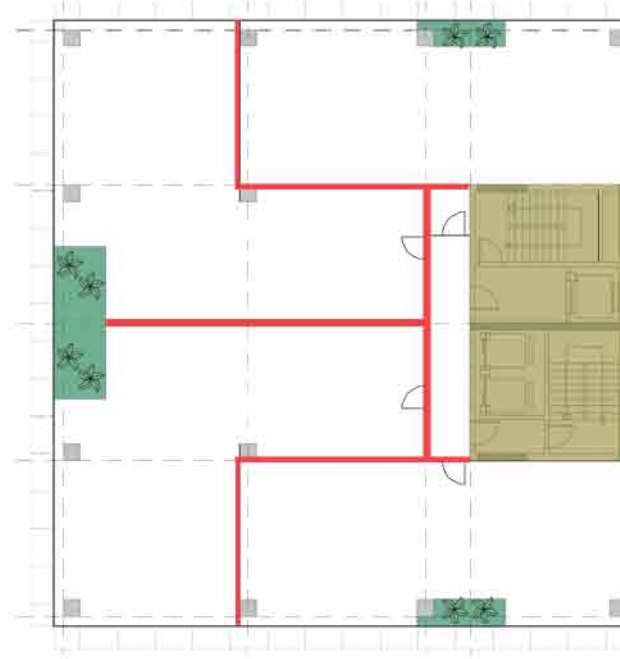

4 OFIS

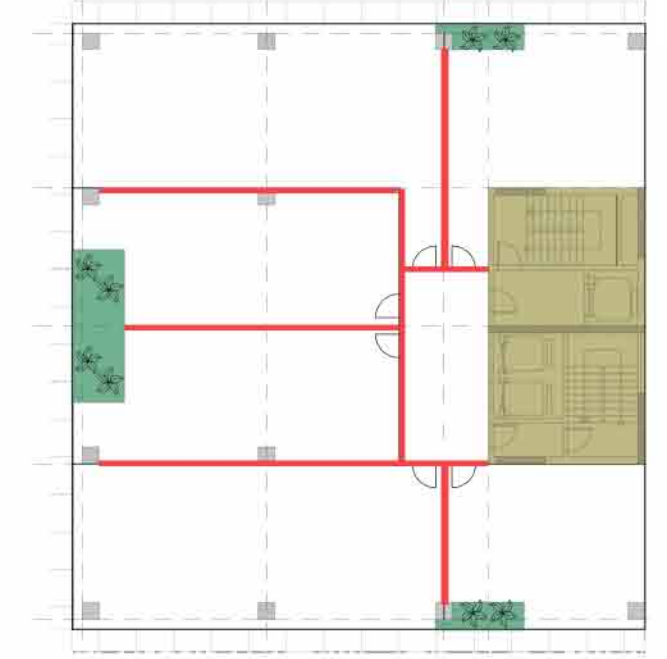

6 OFIS



METROPOLIST

KAT TIPLERİ

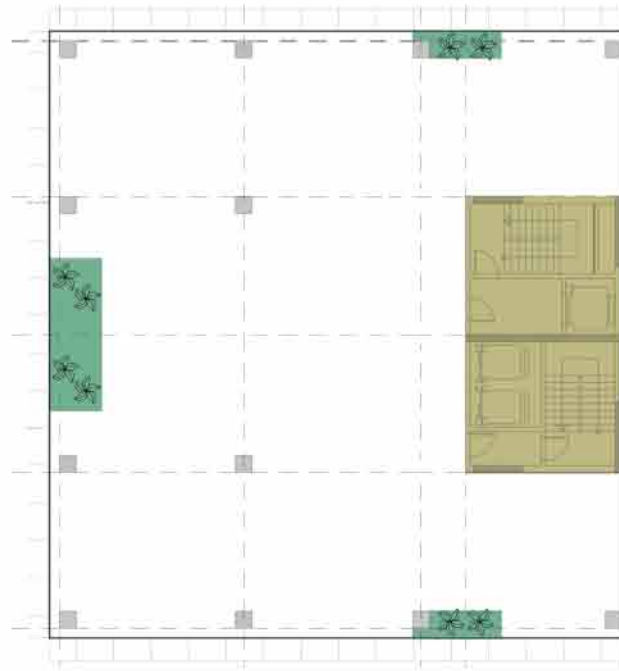

OFIS

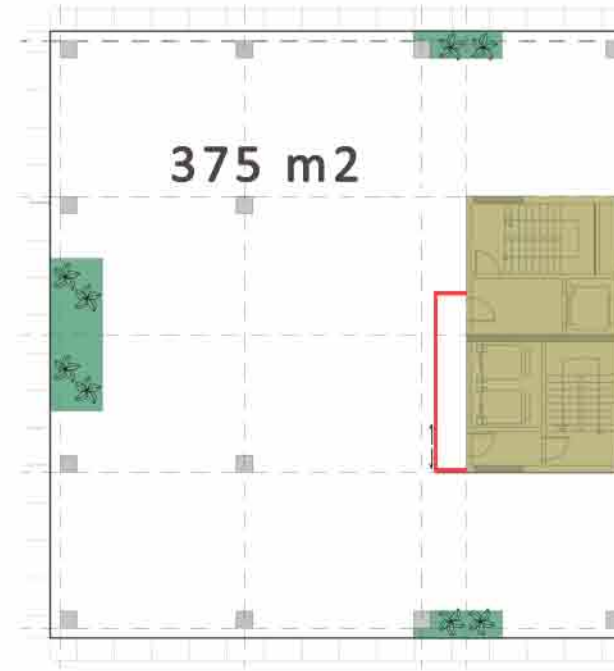

1 OFIS

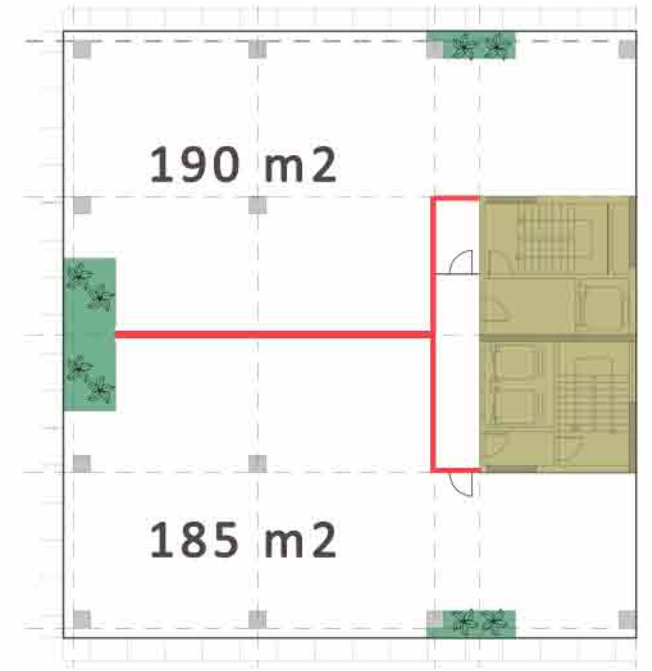

2 OFIS

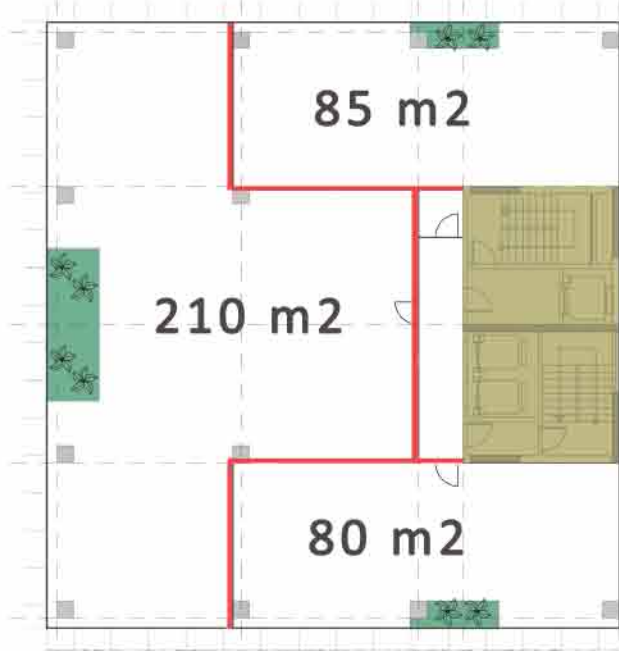

3 OFIS

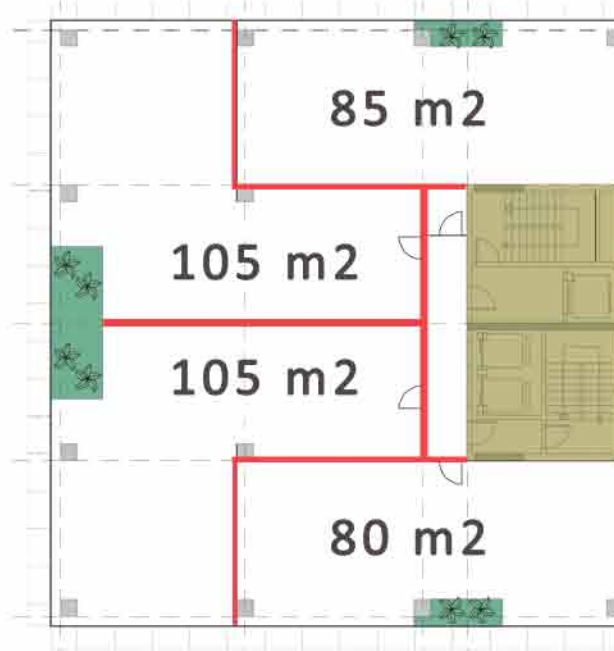

4 OFIS

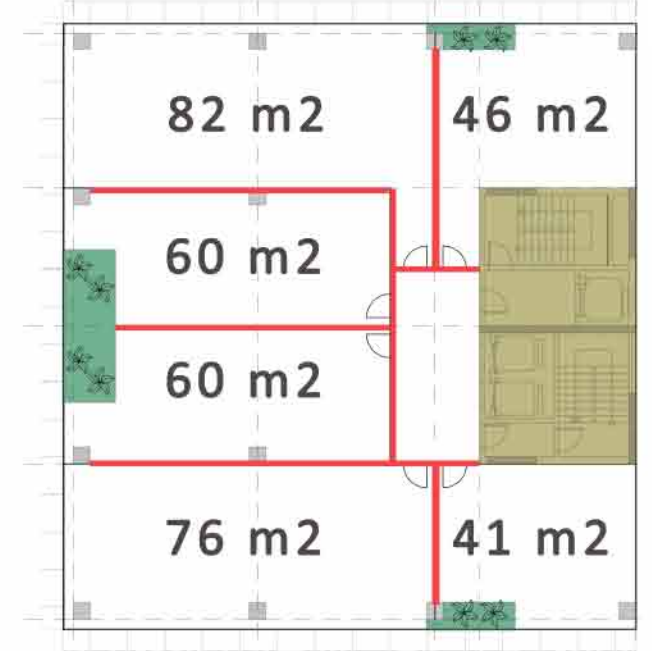

6 OFIS

375 m<sup>2</sup>

190 m<sup>2</sup>

185 m<sup>2</sup>

85 m<sup>2</sup>

210 m<sup>2</sup>

80 m<sup>2</sup>

85 m<sup>2</sup>

105 m<sup>2</sup>

105 m<sup>2</sup>

80 m<sup>2</sup>

82 m<sup>2</sup>

46 m<sup>2</sup>

60 m<sup>2</sup>

60 m<sup>2</sup>

76 m<sup>2</sup>

41 m<sup>2</sup>



METROPOLIST

ŞEMATİK KESİT

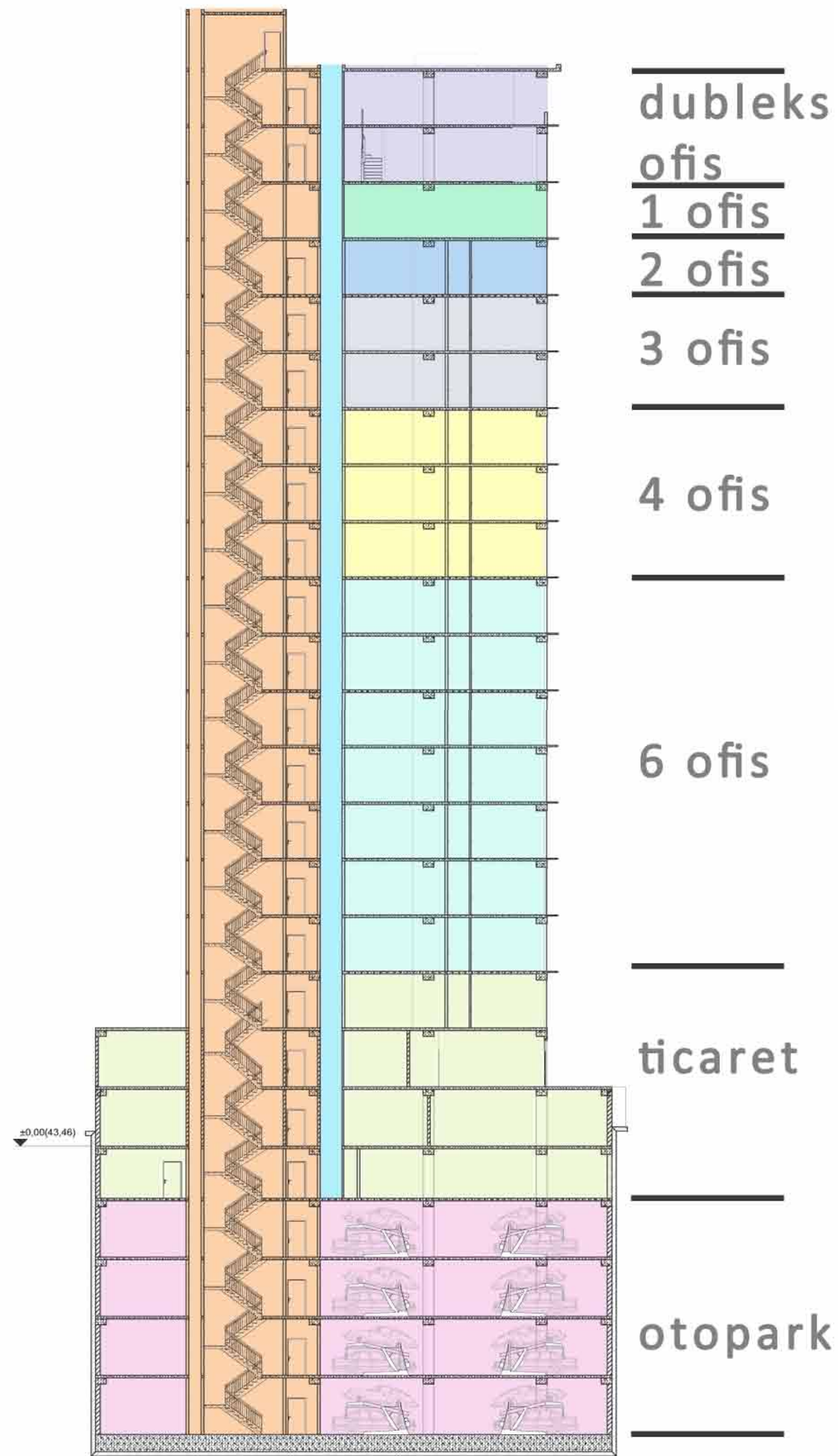



METROPOLIST

1 ofis  
kat tipi

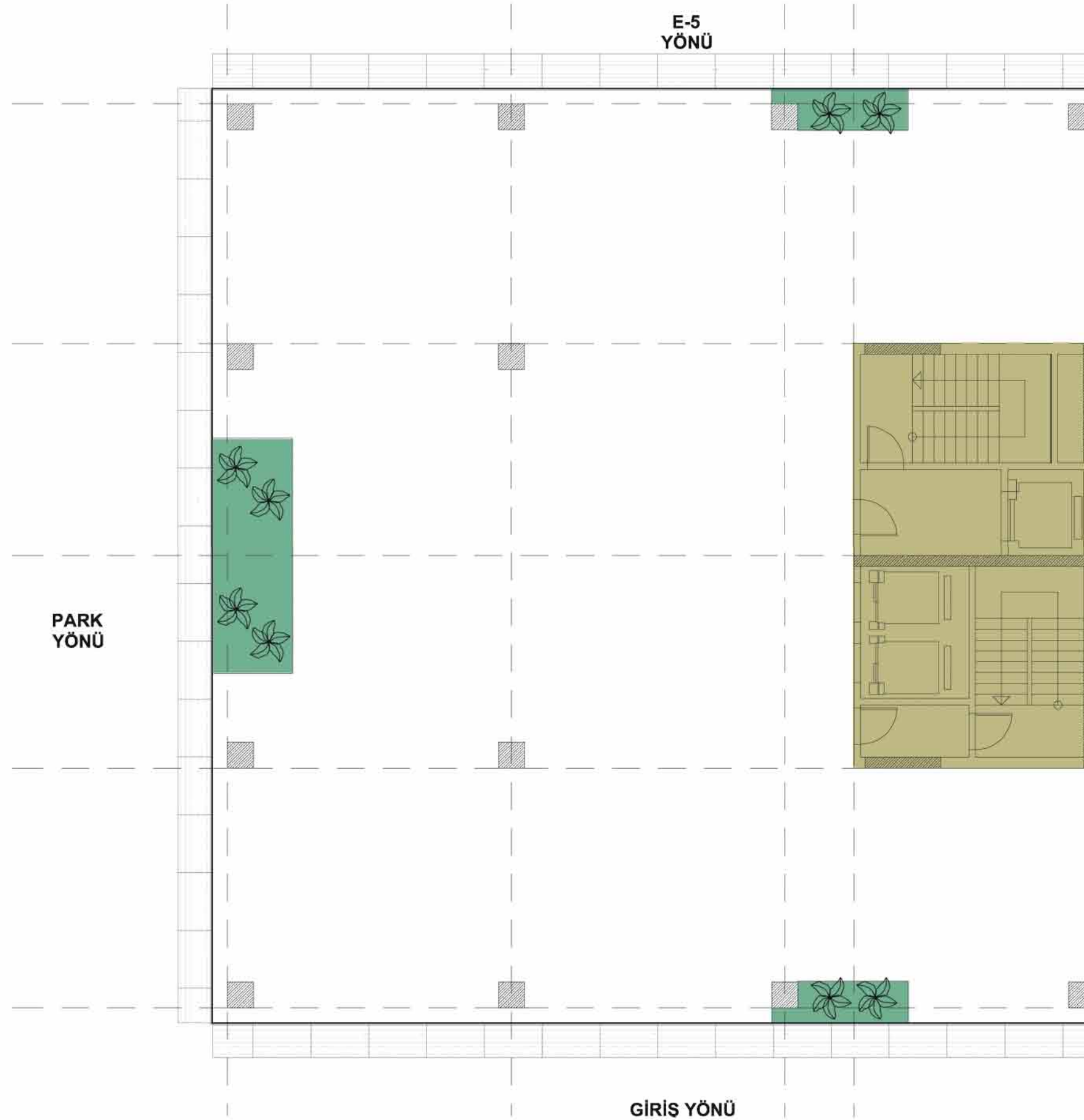



METROPOLIST

1 ofis  
kat tipi

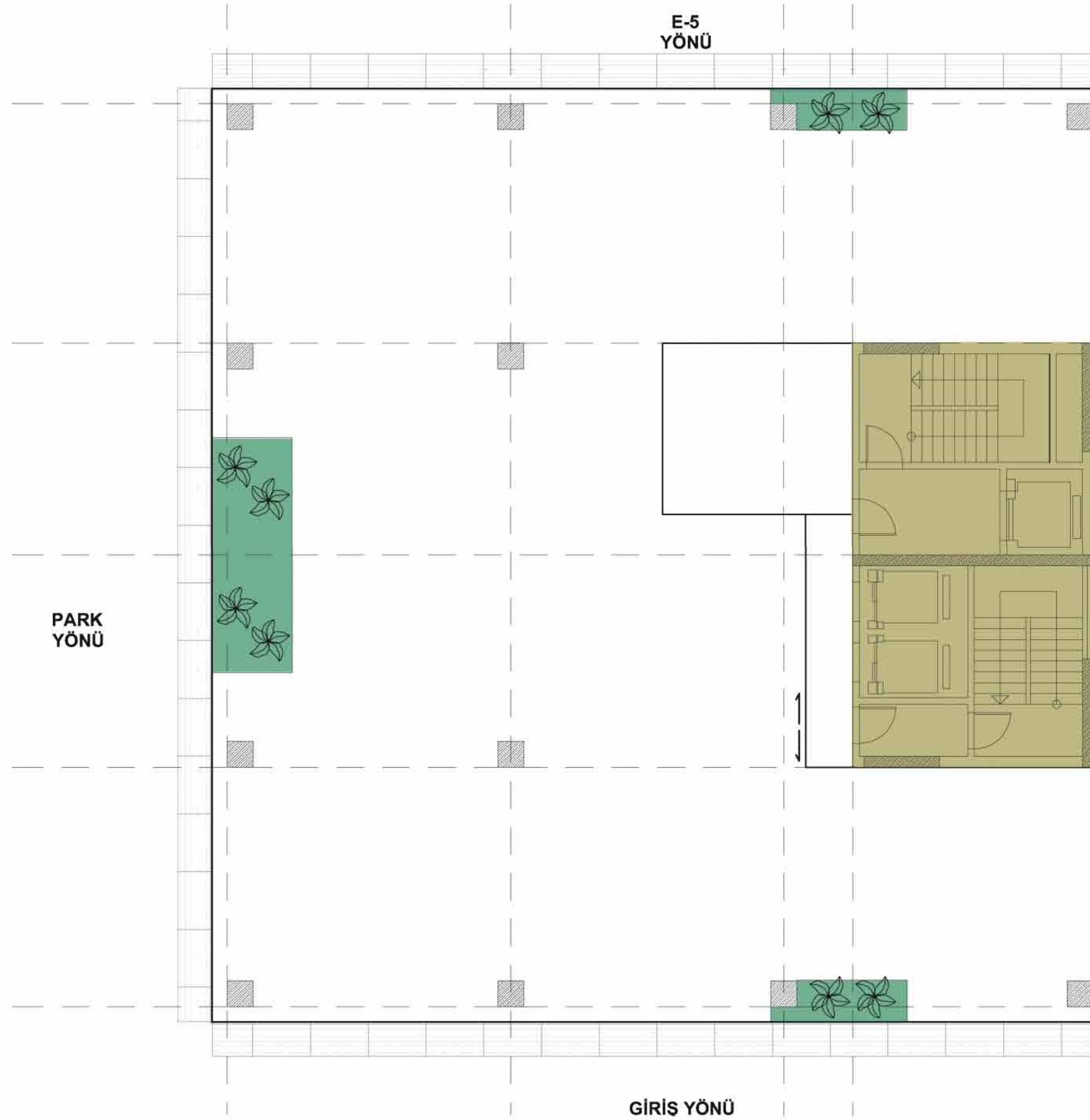

duvarlar



METROPOLIST

1 ofis  
kat tipi

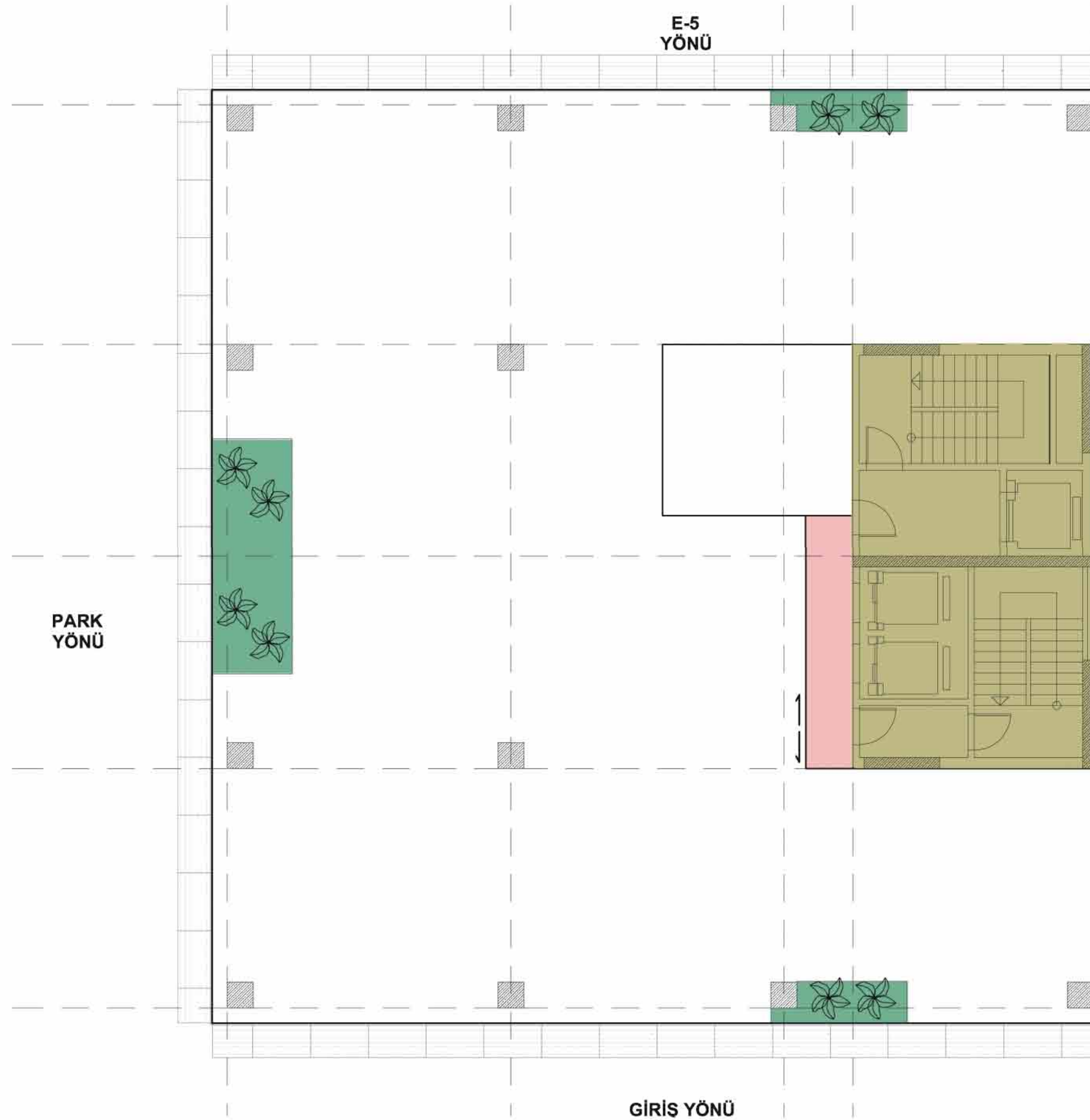

kat sirkulasyon  
duvarlar

**DÖRE**  
ARCHITECTS



METROPOLIST

1 ofis  
kat tipi

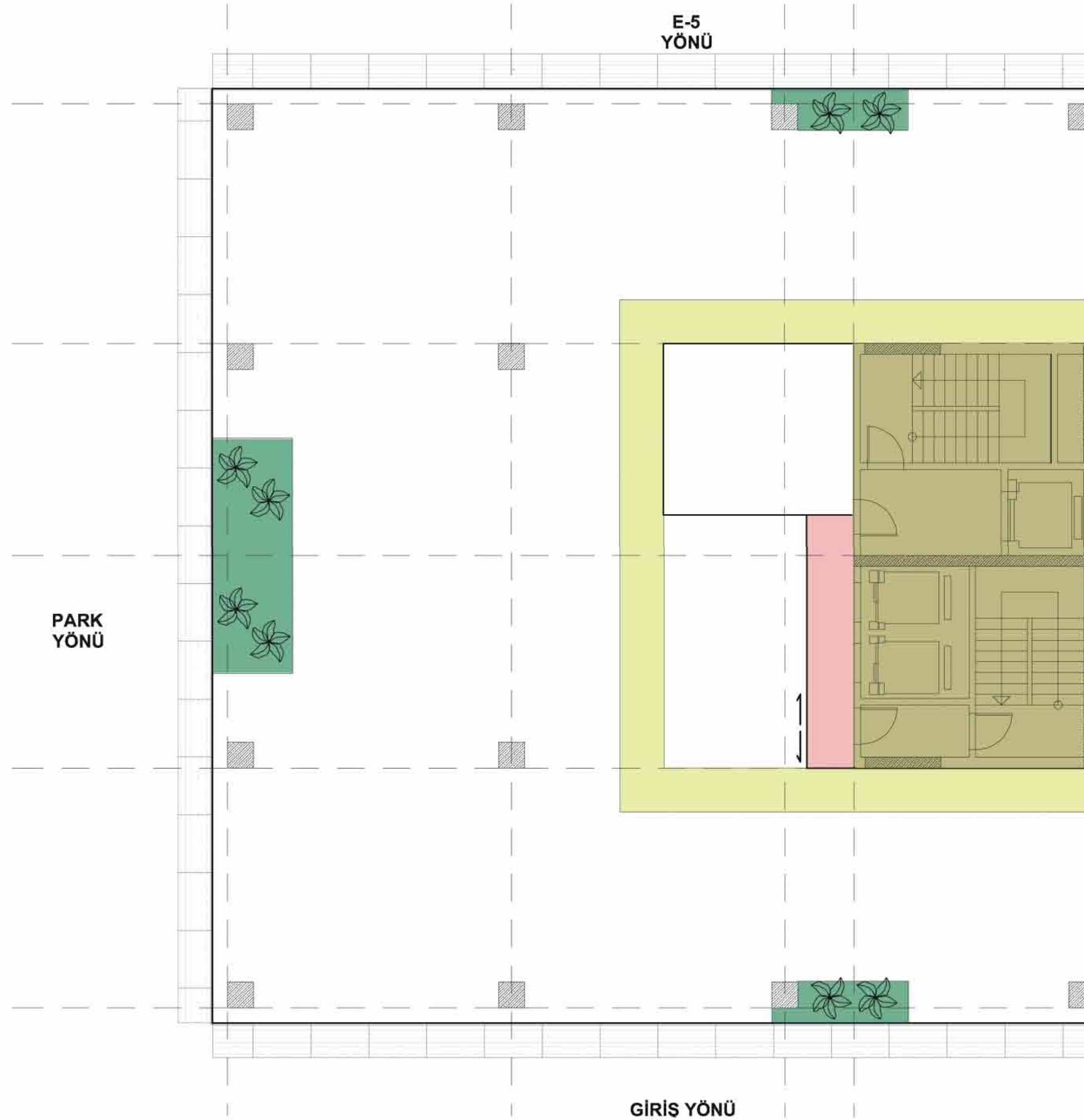

ic sirkulasyon  
kat sirkulasyon  
duvarlar

DORE  
ARCHITECTS



METROPOLIST

1 ofis  
kat tipi

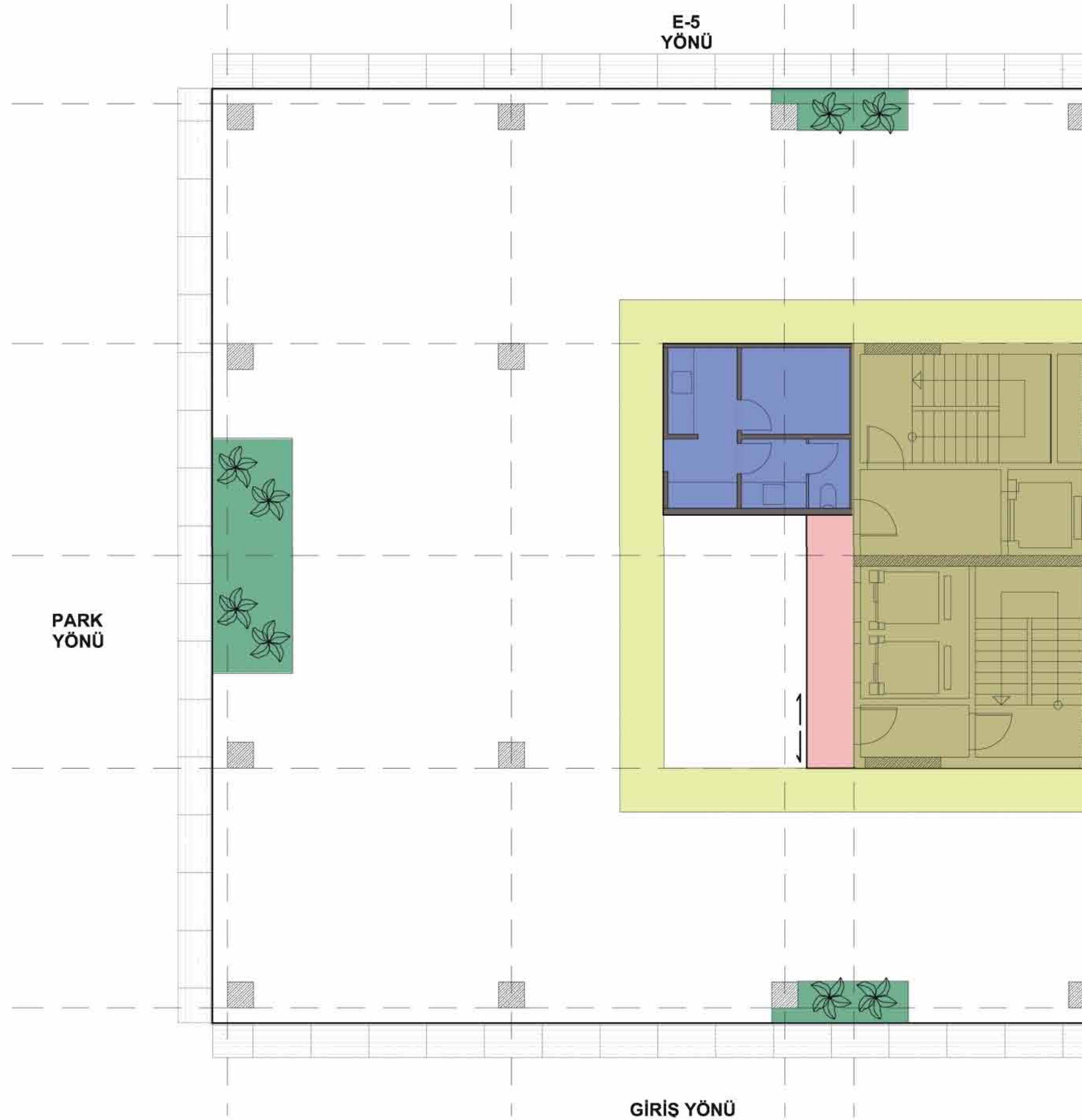

Islak hacim  
ic sirkulasyon  
kat sirkulasyon  
duvarlar





METROPOLIST

1 ofis  
kat tipi

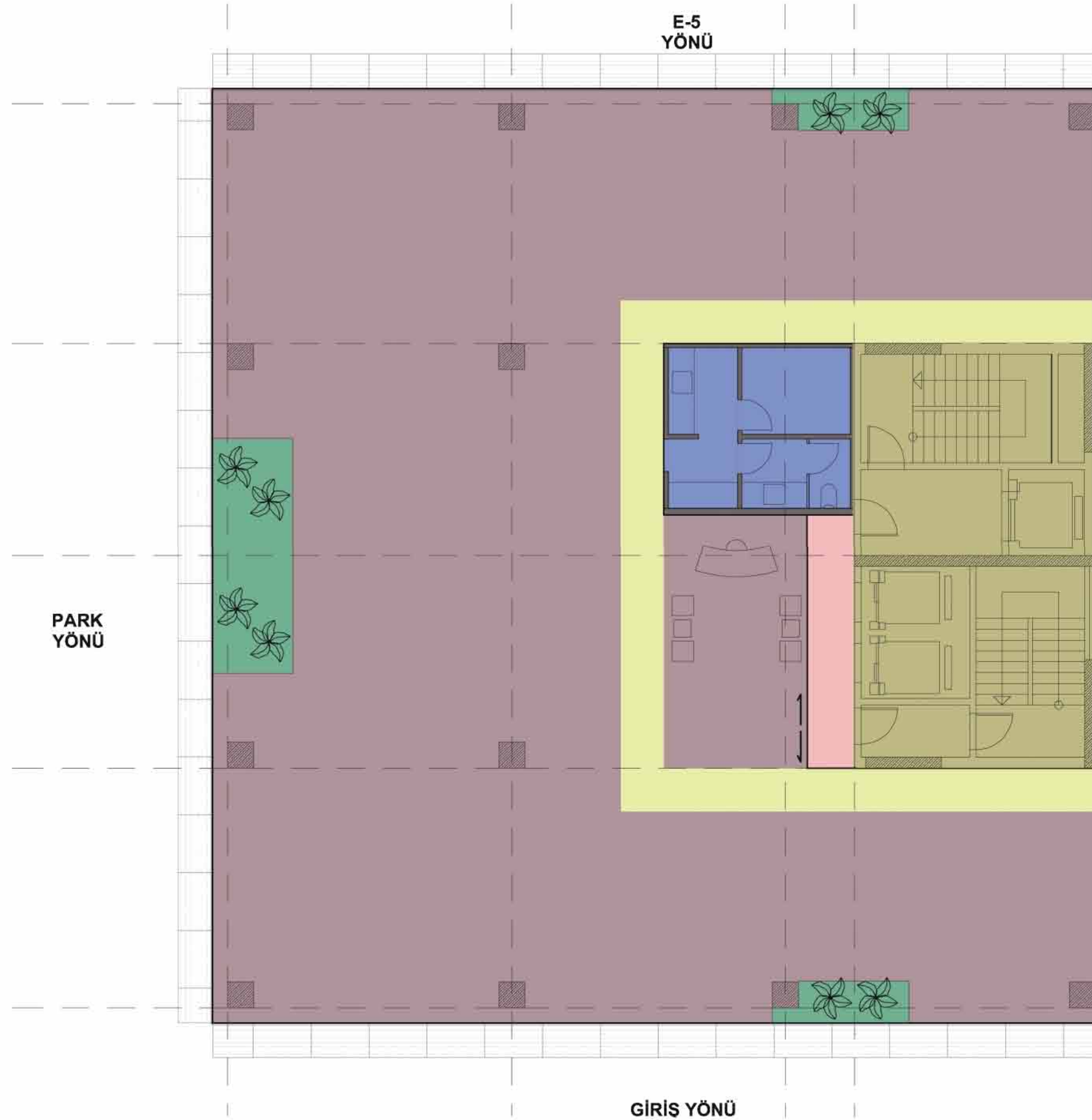

ofis tip  
Islak hacim  
ic sirkulasyon  
kat sirkulasyon  
duvarlar



METROPOLIST

2'li ofis  
kat tipi

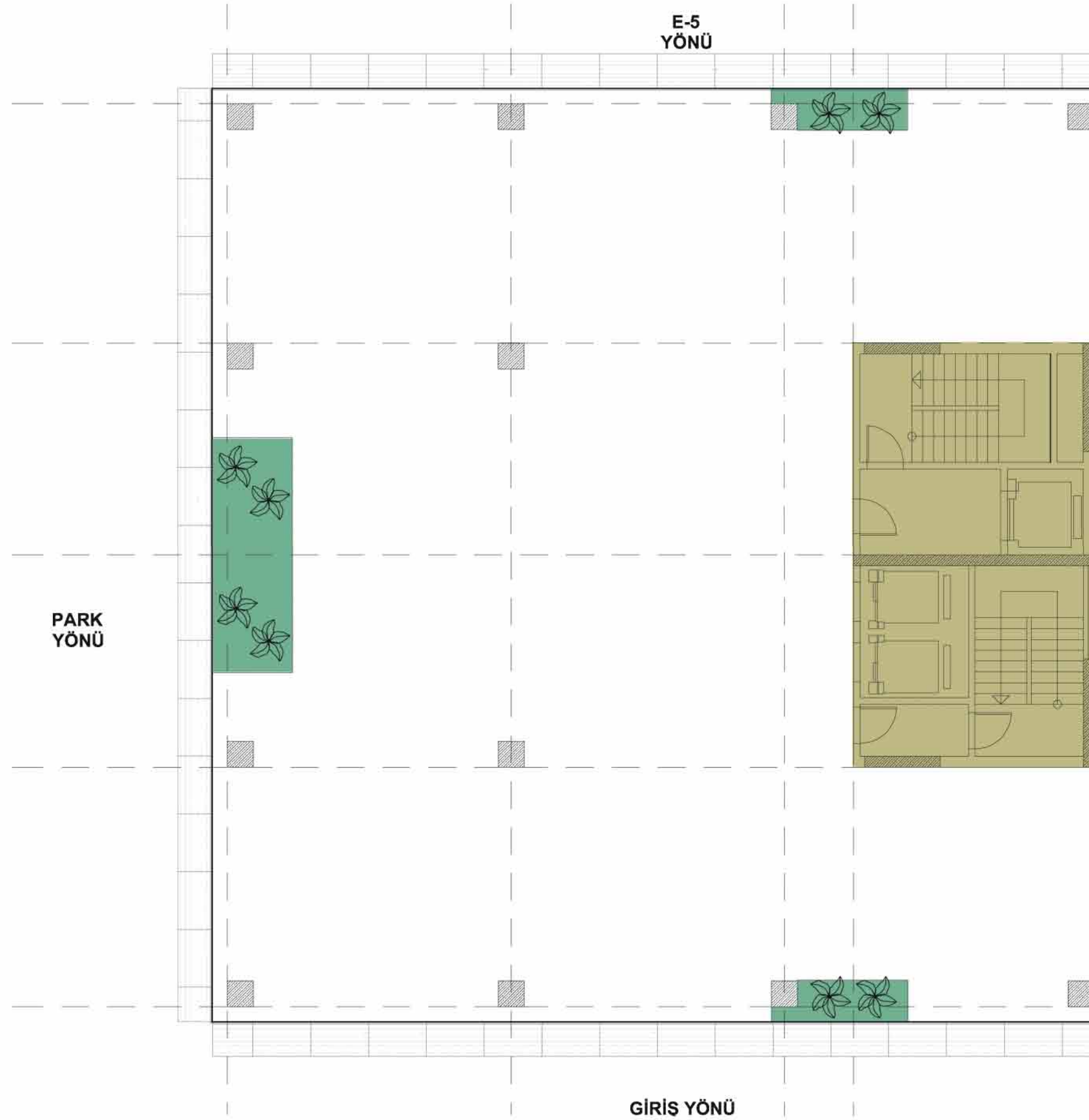



METROPOLIST

2'li ofis  
kat tipi

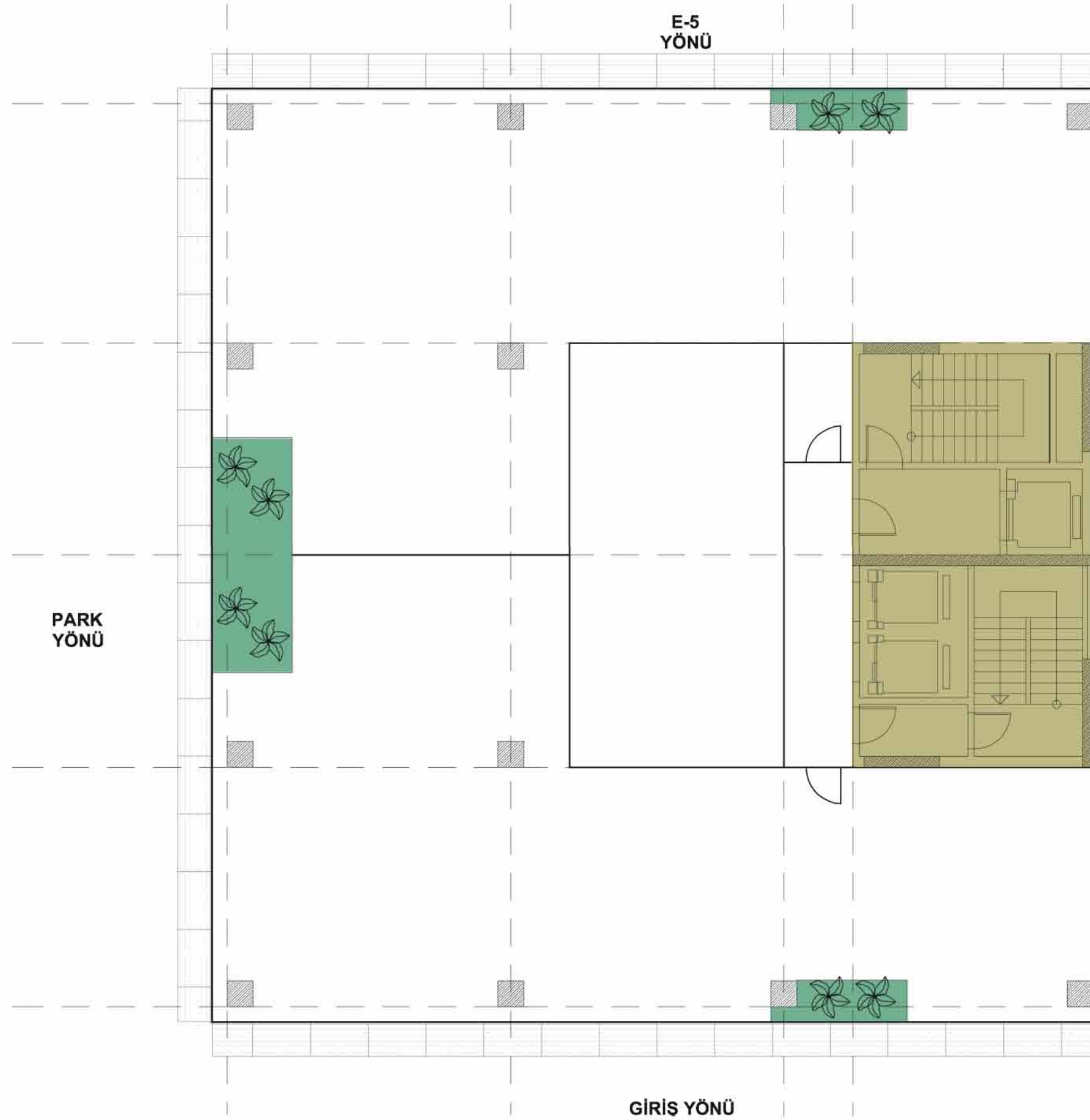



METROPOLIST

2'li ofis  
kat tipi

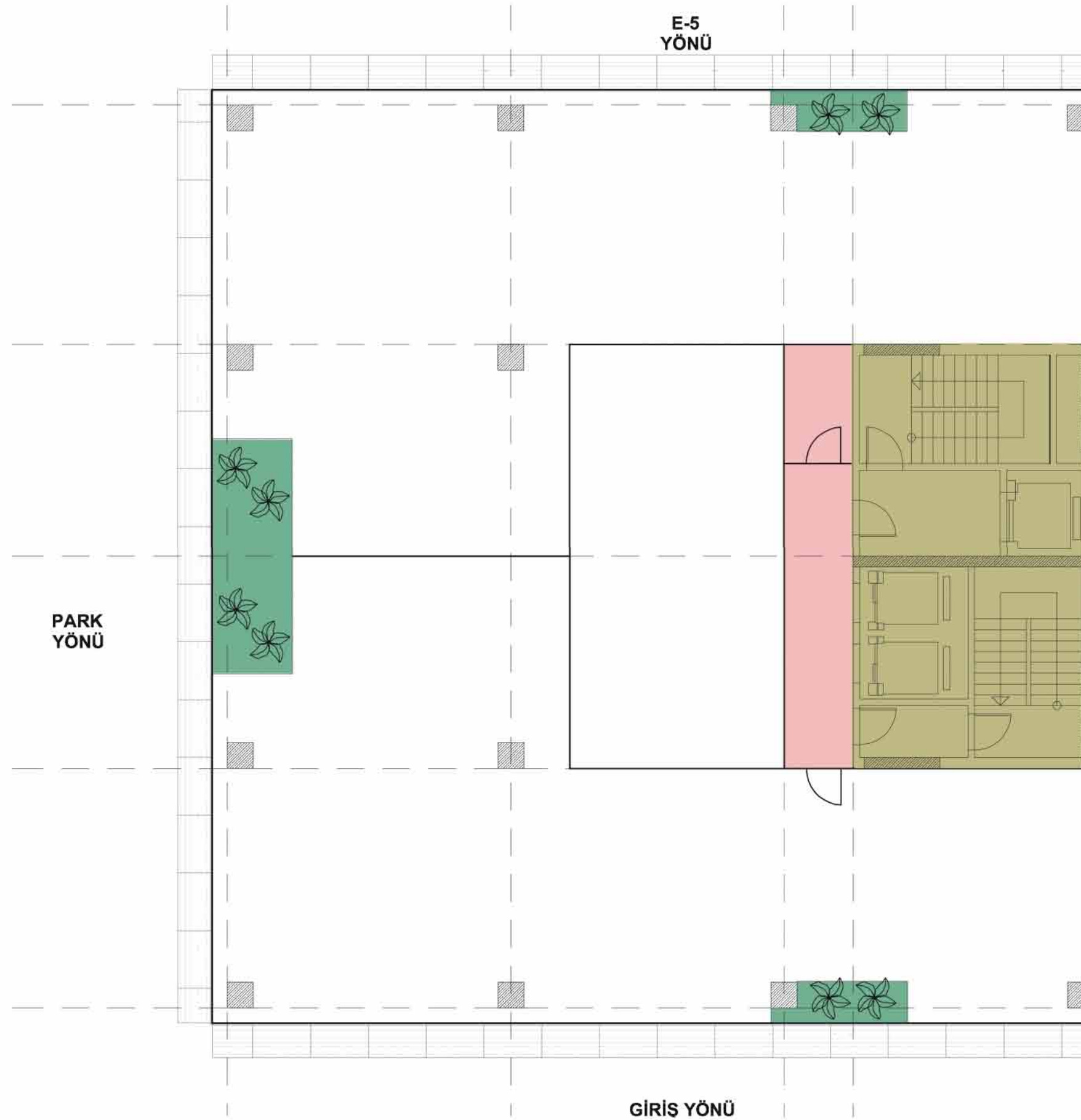

kat sirkulasyon  
duvarlar

**DORE**  
ARCHITECTS



METROPOLIST

2'li ofis  
kat tipi

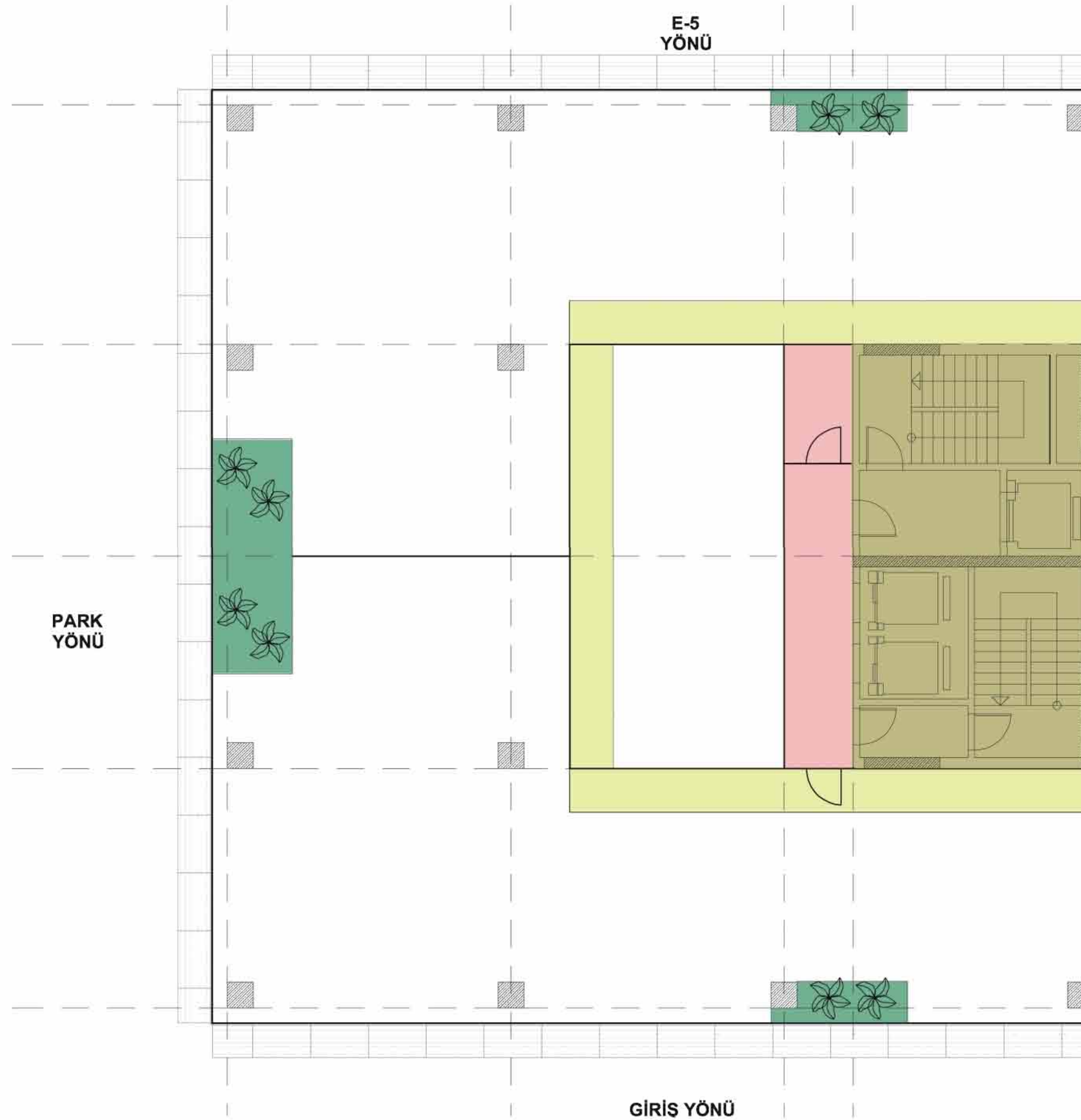

ic sirkulasyon  
kat sirkulasyon  
duvarlar



METROPOLIST

2'li ofis  
kat tipi

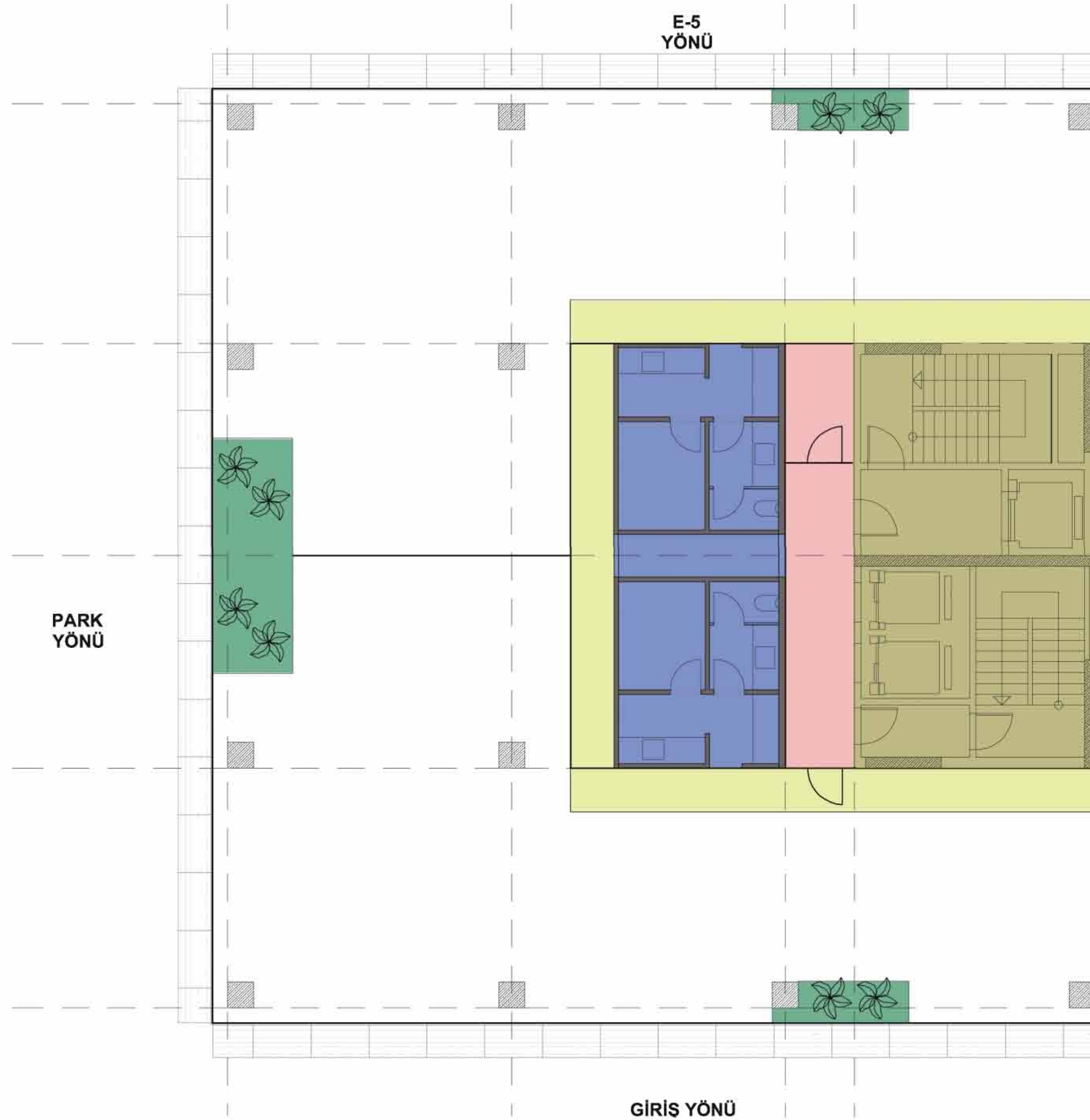

Islak hacim  
ic sirkulasyon  
kat sirkulasyon  
duvarlar



METROPOLIST

2'li ofis  
kat tipi

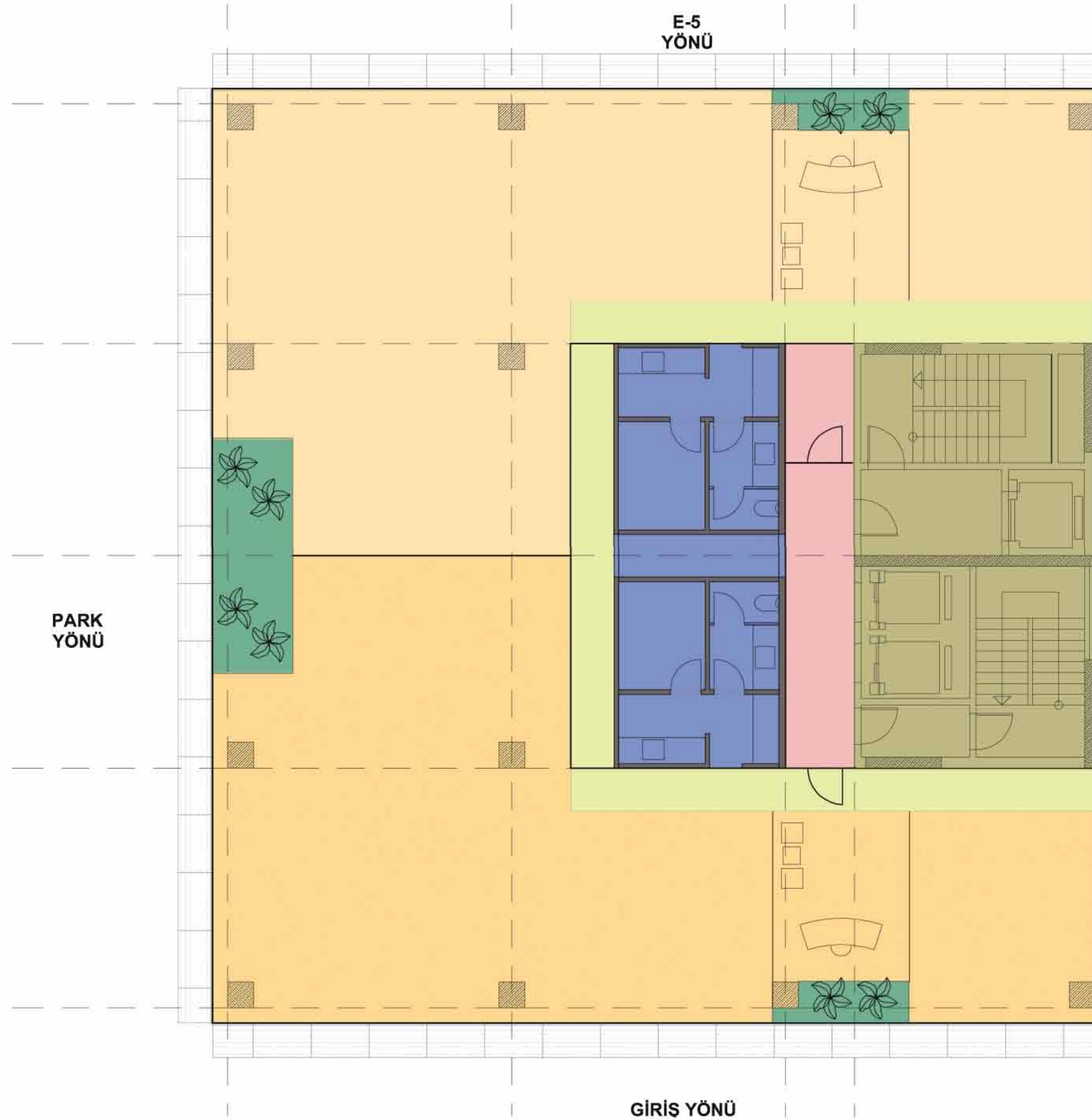

ofis tipleri  
Islak hacim  
ic sirkulasyon  
kat sirkulasyon  
duvarlar









METROPOLIST

3'lü ofis  
kat tipi

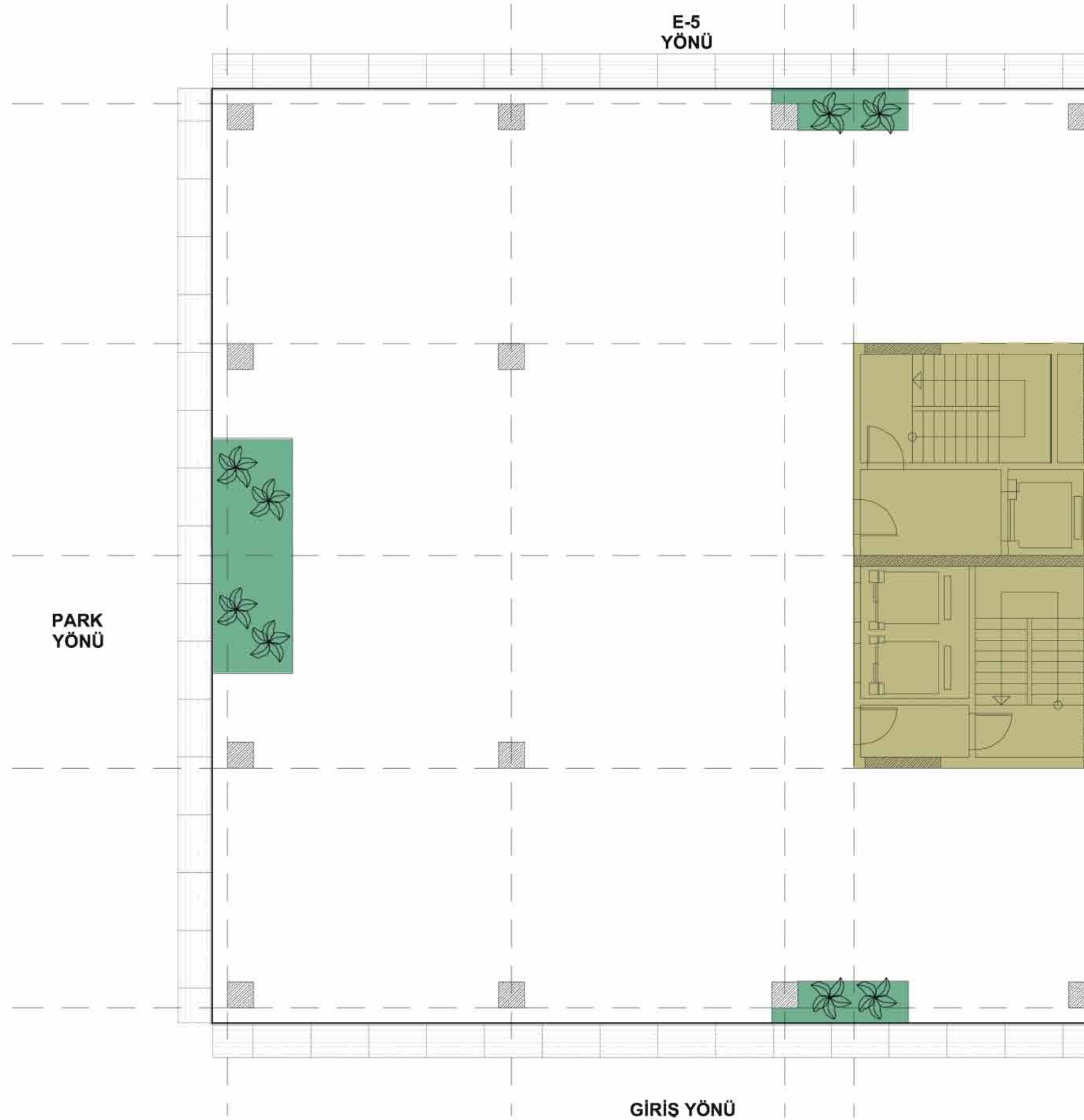



METROPOLIST

3'lü ofis  
kat tipi

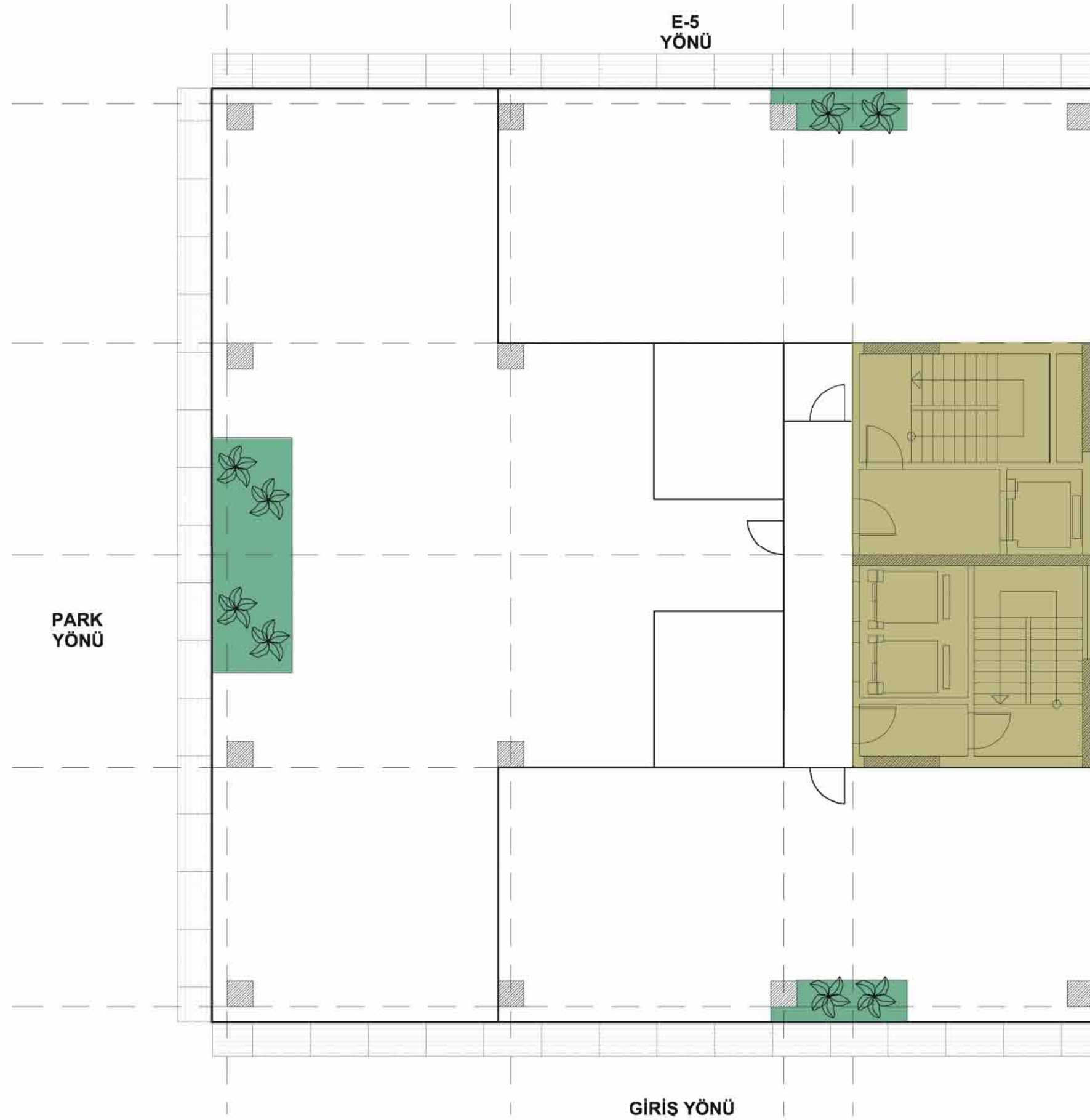

duvarlar



METROPOLIST

3'lü ofis  
kat tipi

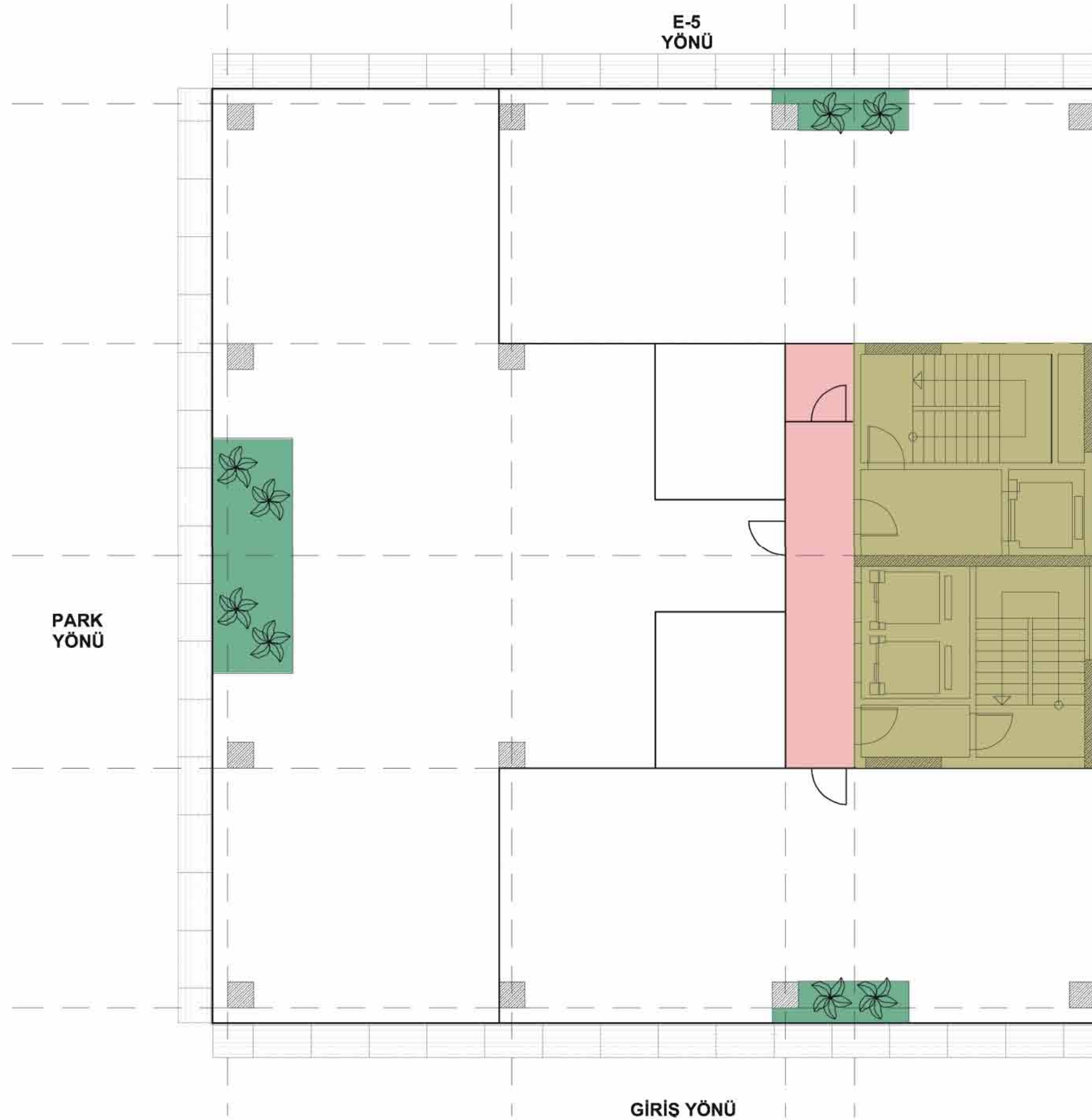

kat sirkülasyon  
duvarlar

**DÖRE**  
ARCHITECTS



METROPOLIST

3'lü ofis  
kat tipi

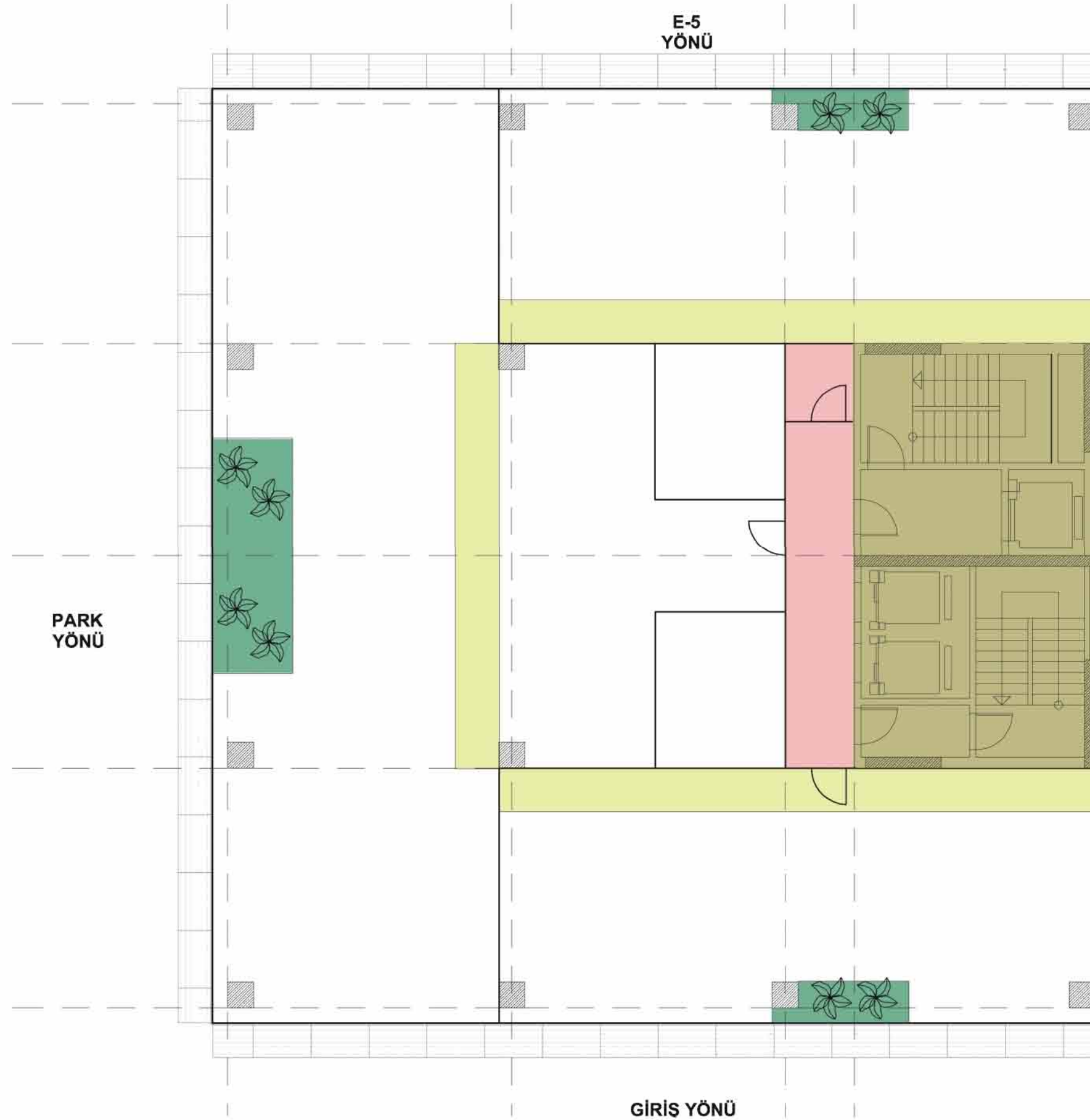

ic sirkulasyon  
kat sirkülasyon  
duvarlar

DÖRE  
ARCHITECTS



METROPOLIST

3'lü ofis  
kat tipi

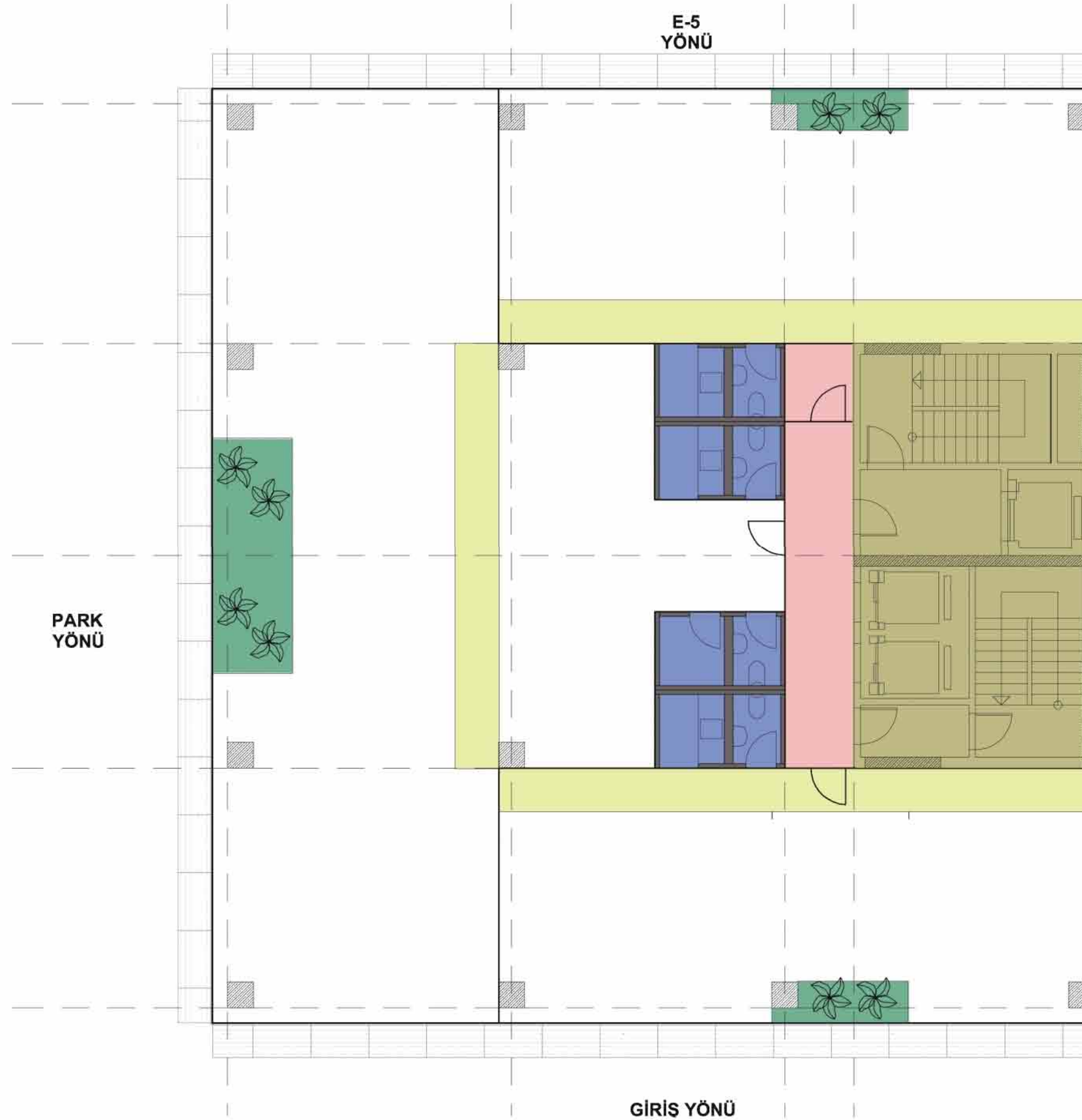

Islak hacim  
ic sirkulasyon  
kat sirkülasyon  
duvarlar



METROPOLIST

3'lü ofis  
kat tipi



ofis tipleri  
Islak hacim  
ic sirkulasyon  
kat sirkulasyon  
duvarlar

DÖRE  
ARCHITECTS









METROPOLIST

4'lü ofis  
kat tipi

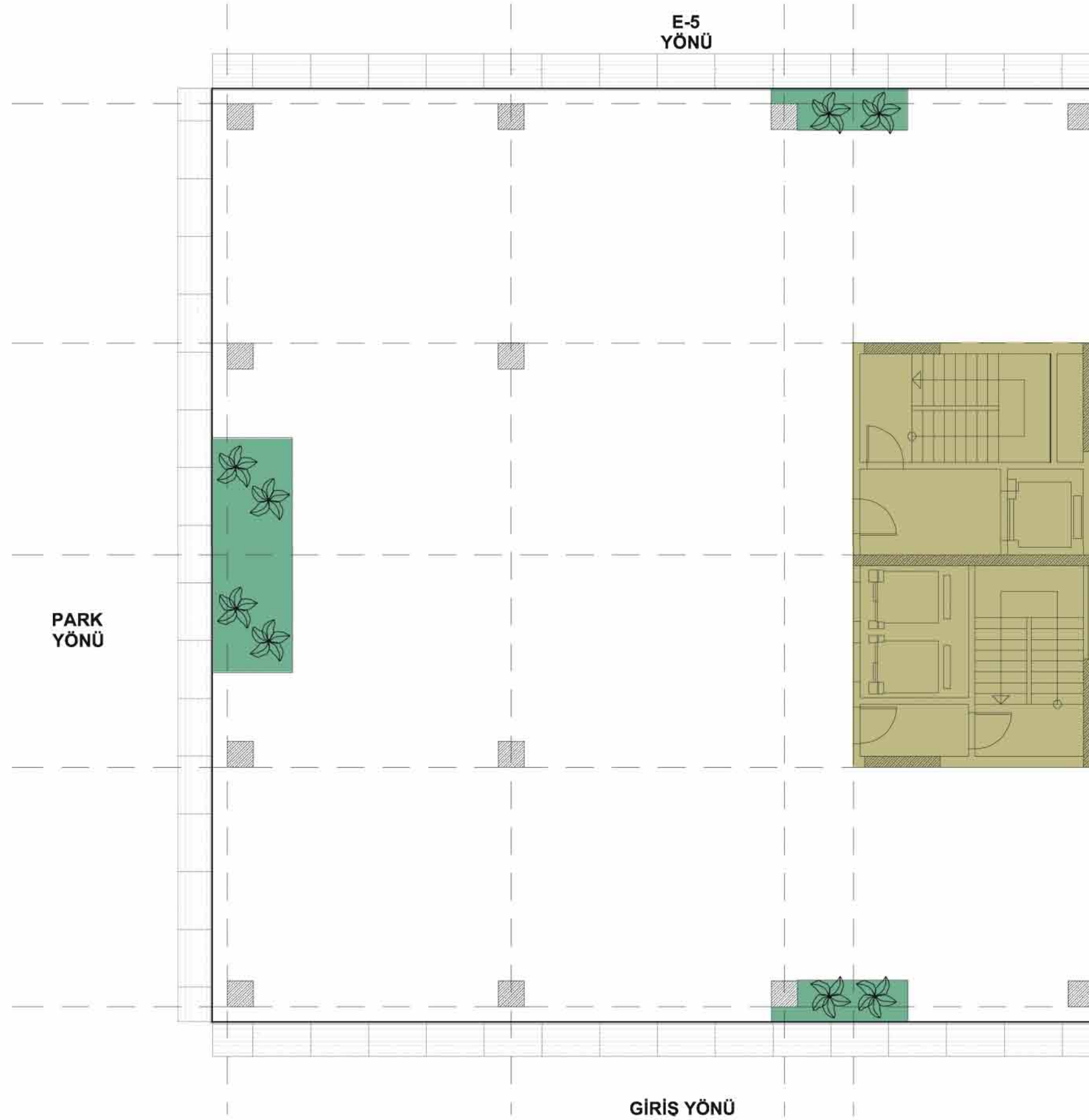



METROPOLIST

4'lü ofis  
kat tipi

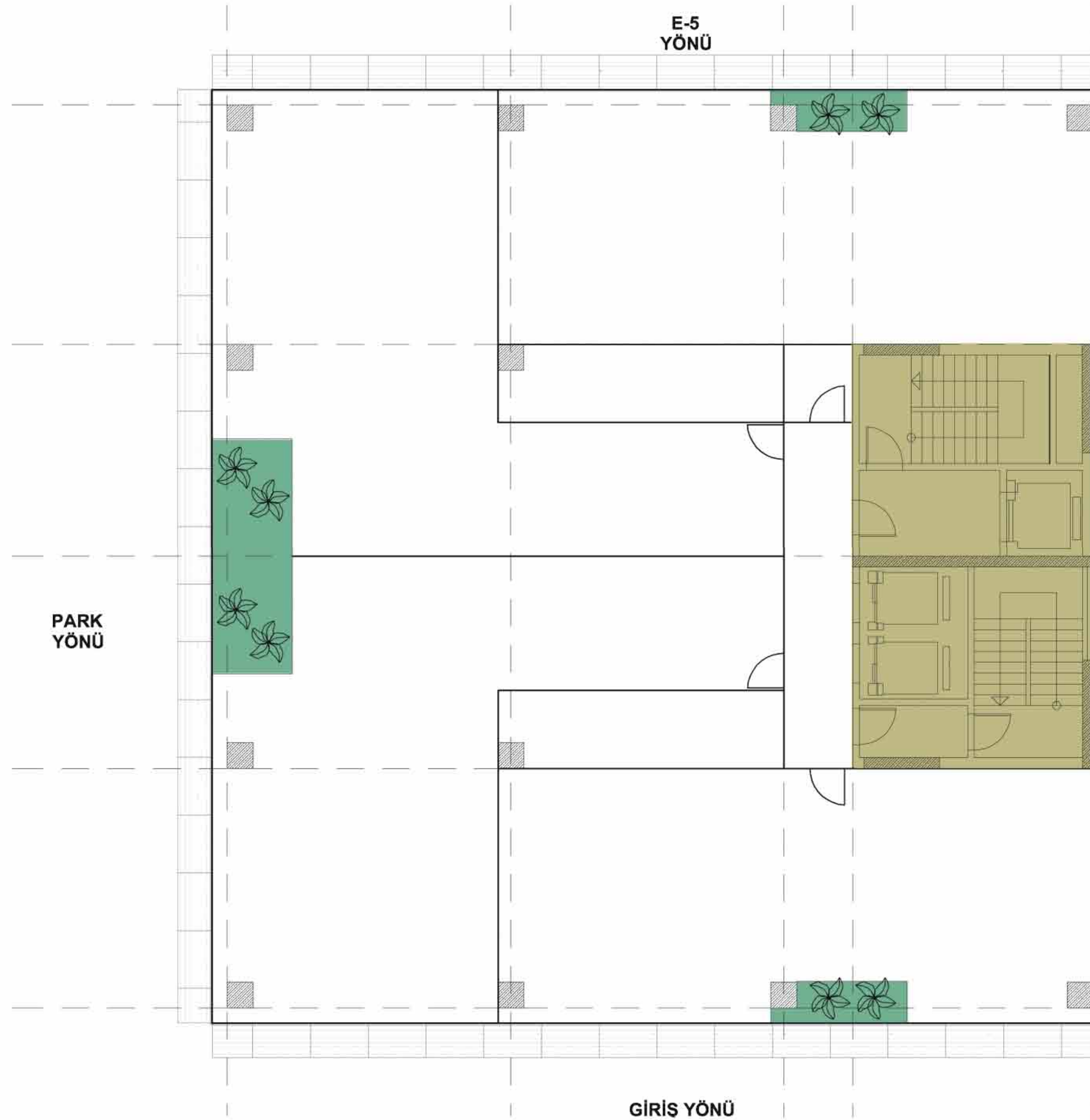



METROPOLIST

4'lü ofis  
kat tipi

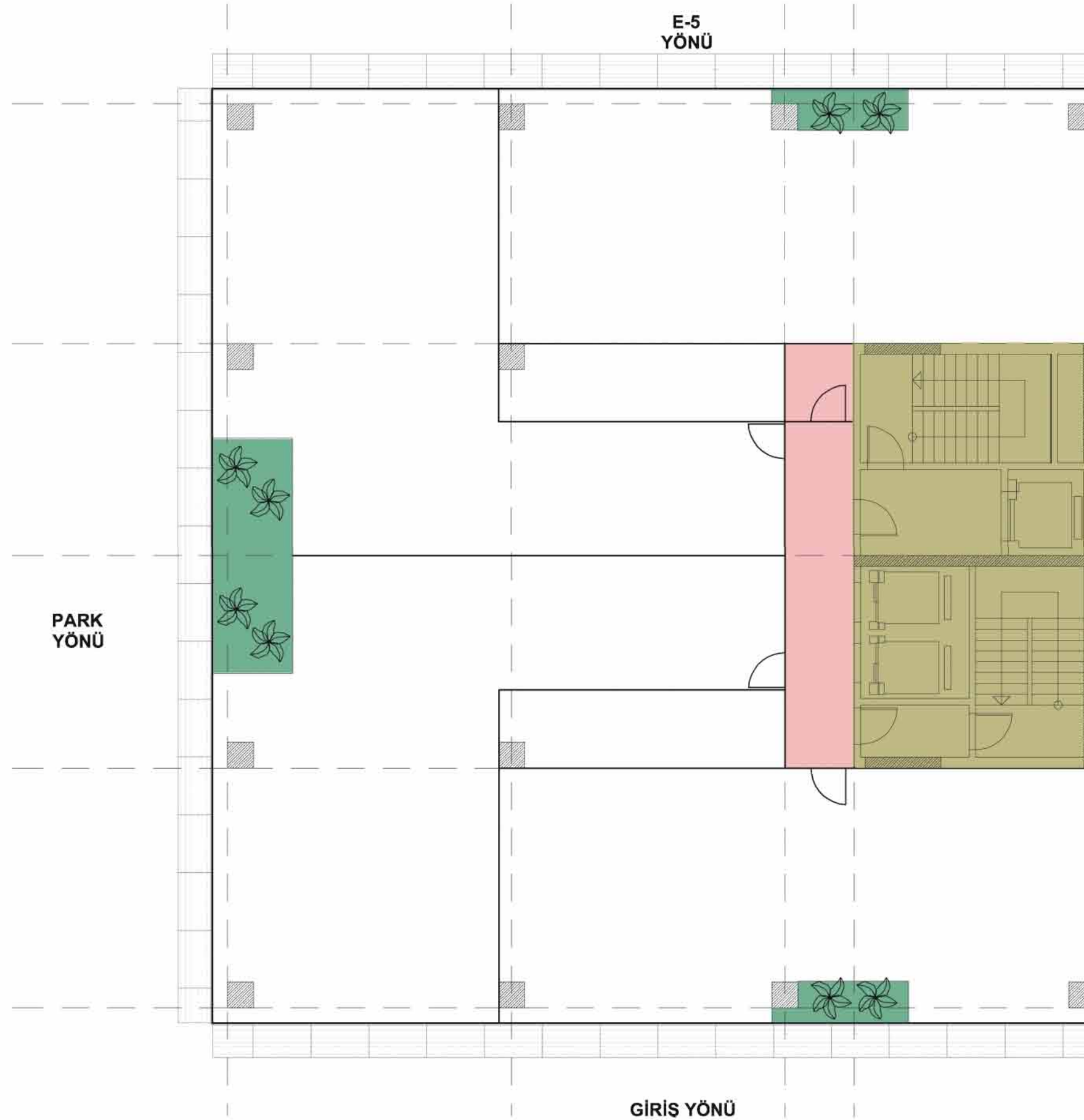

kat sirkülasyon  
duvarlar

**DÖRE**  
ARCHITECTS



METROPOLIST

4'lü ofis  
kat tipi

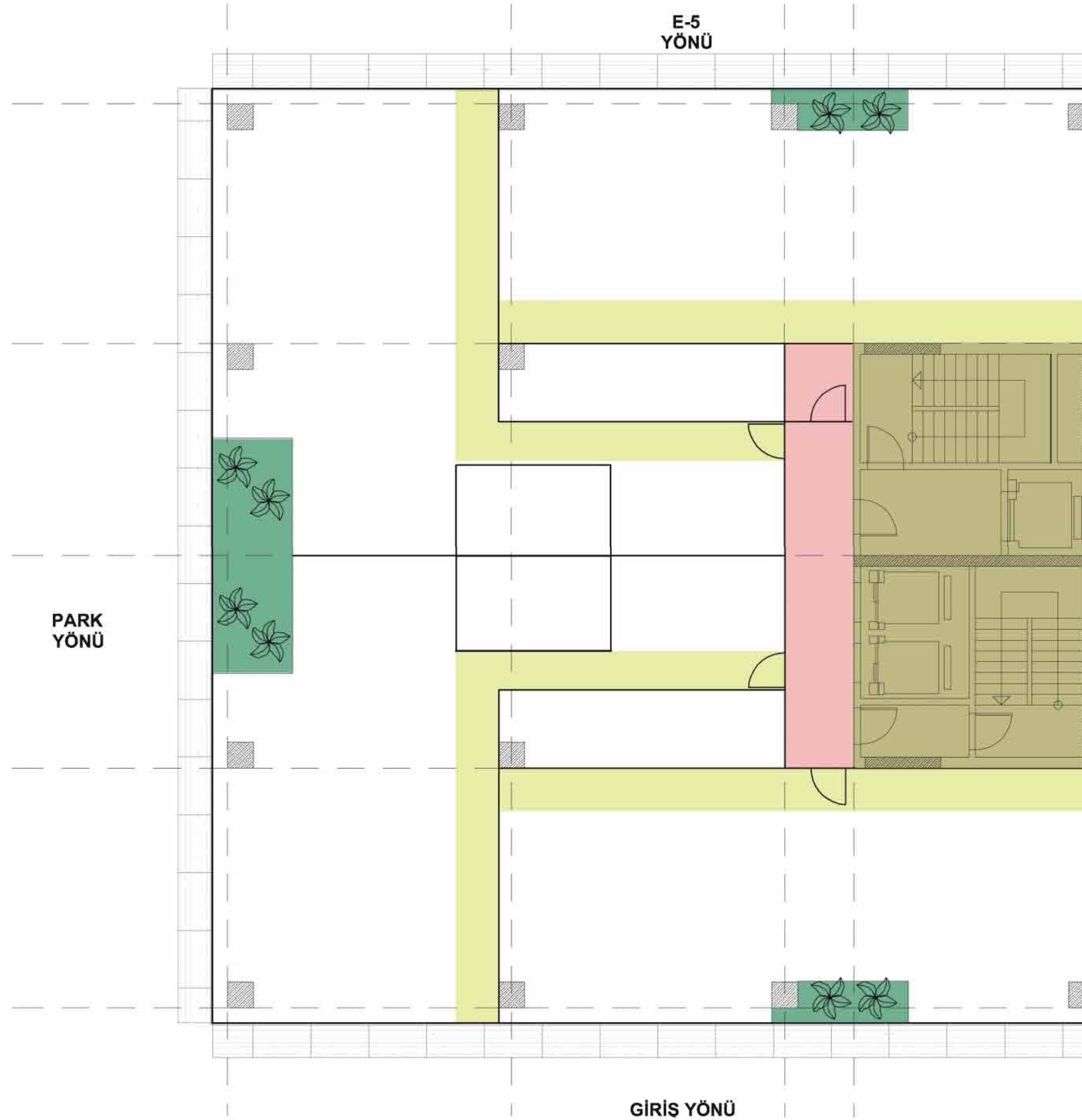

ic sirkulasyon  
kat sirkulasyon  
duvarlar



METROPOLIST

4'lü ofis  
kat tipi

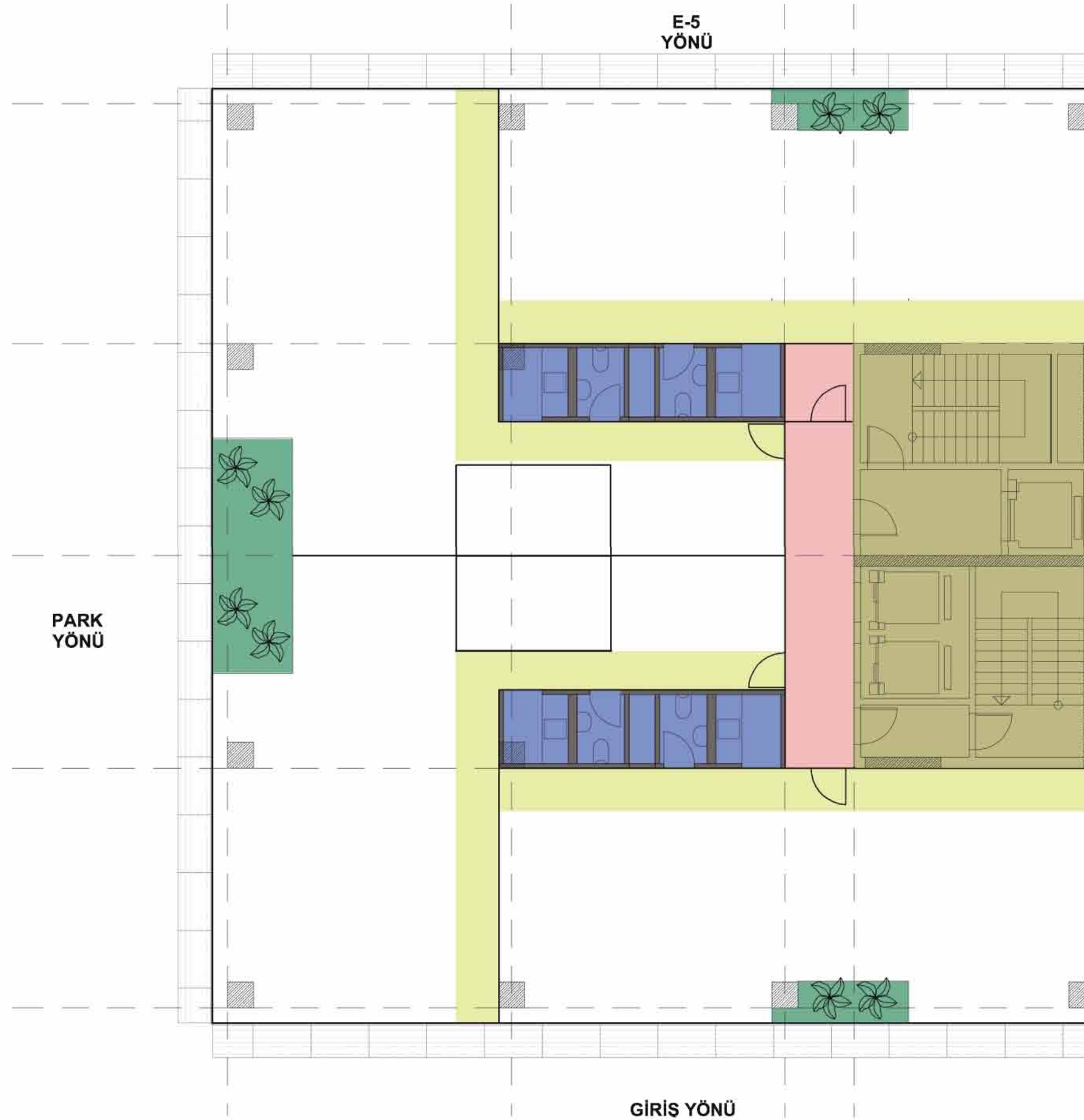

islak hacim  
ic sirkulasyon  
kat sirkulasyon  
duvarlar



METROPOLIST

4'lü ofis  
kat tipi



ofis tipleri  
islak hacim  
ic sirkulasyon  
kat sirkulasyon  
duvarlar







METROPOLIST

6'lı ofis  
kat tipi

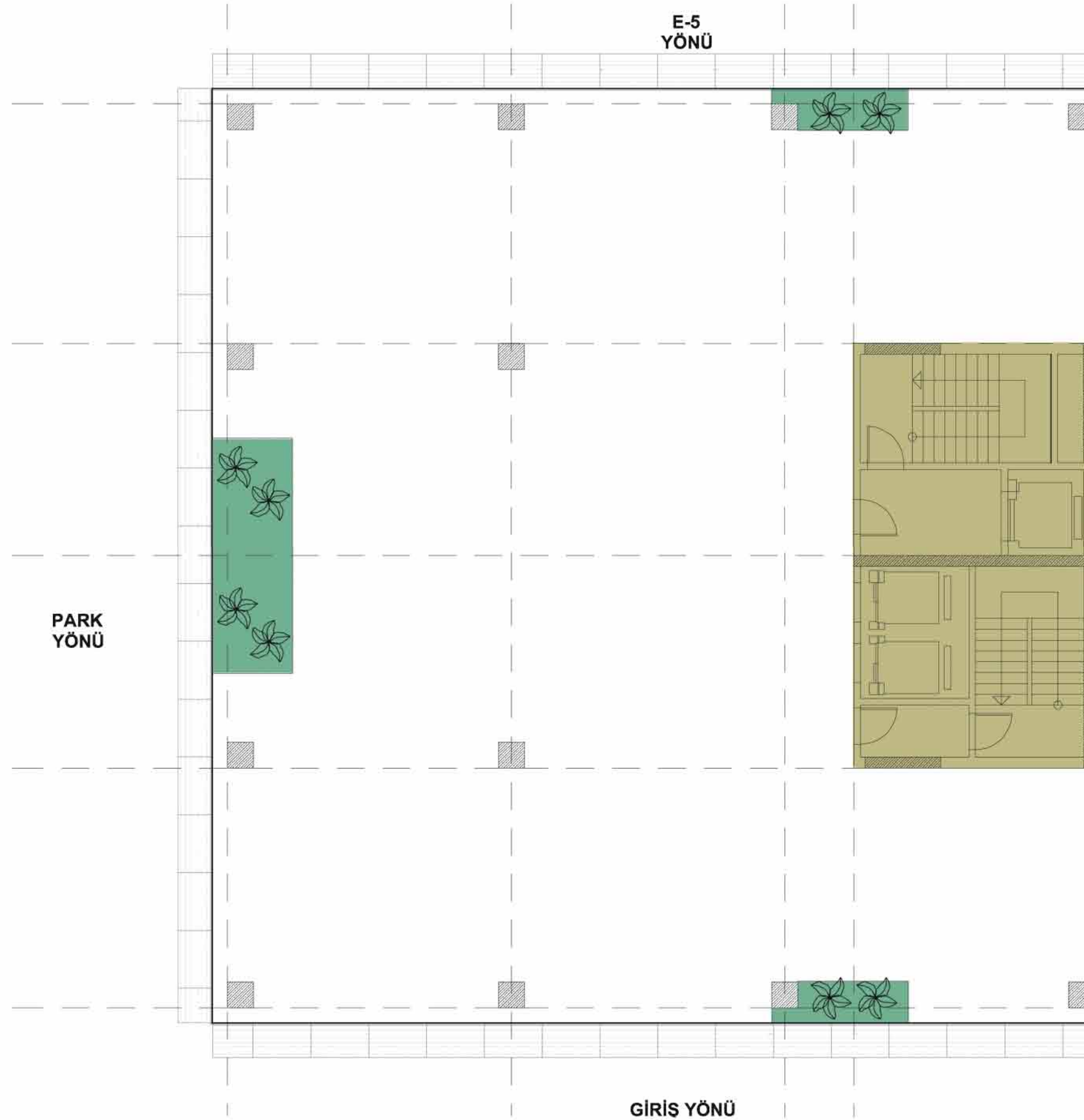



METROPOLIST

6'lı ofis  
kat tipi

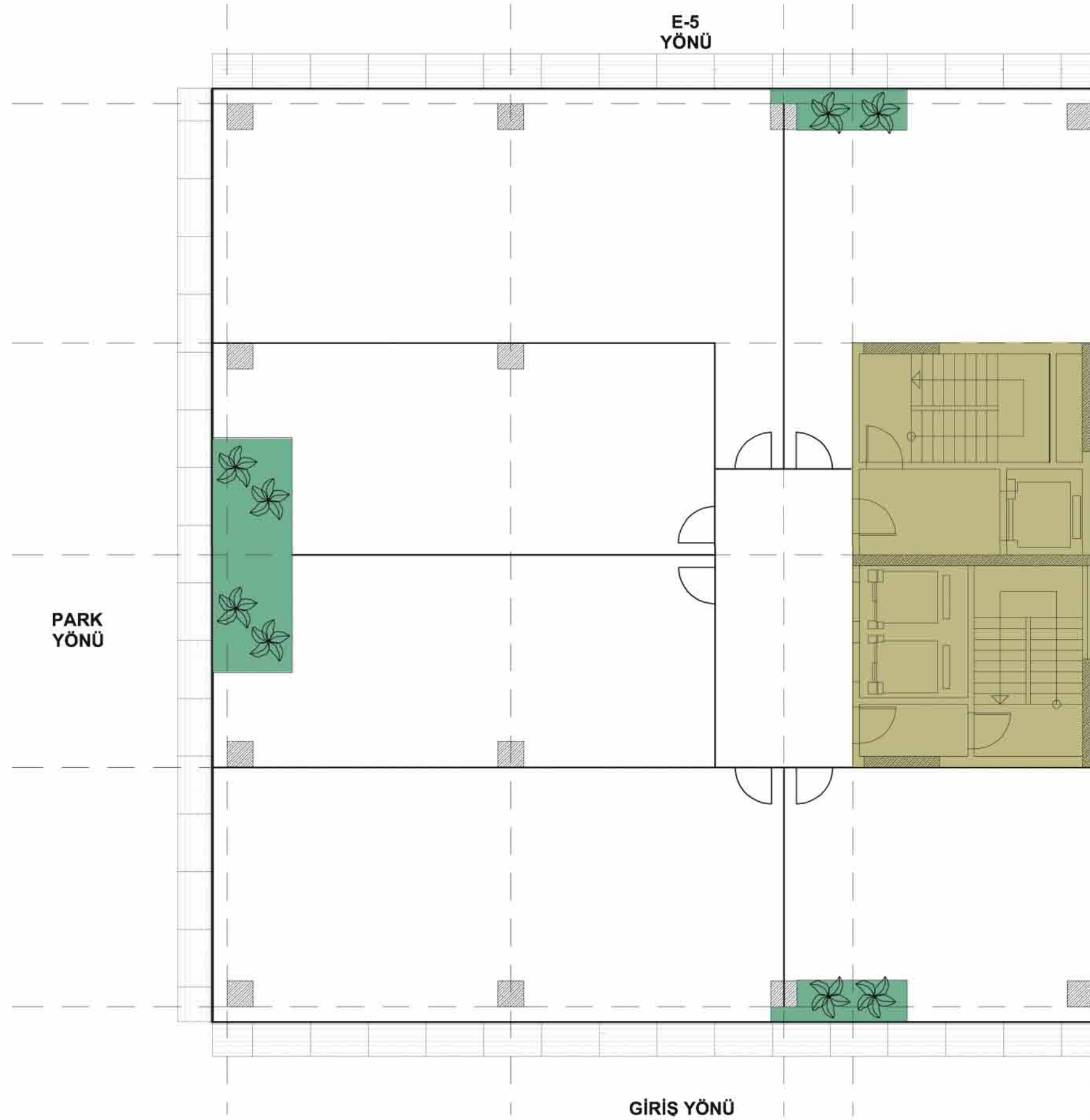



METROPOLIST

6'lı ofis  
kat tipi

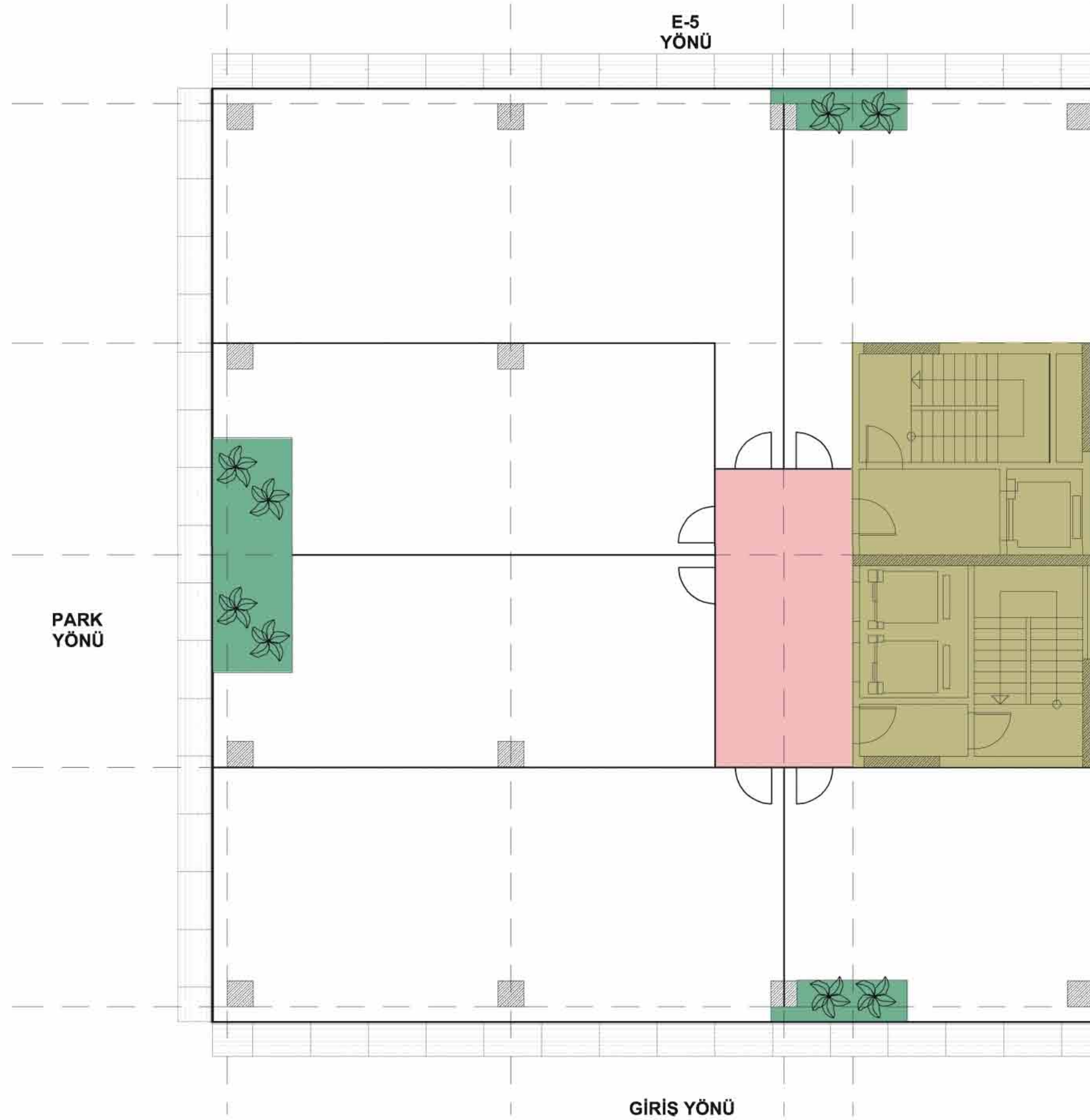

kat sirkülasyon  
duvarlar

**DÖRE**  
ARCHITECTS



METROPOLIST

6'lı ofis  
kat tipi

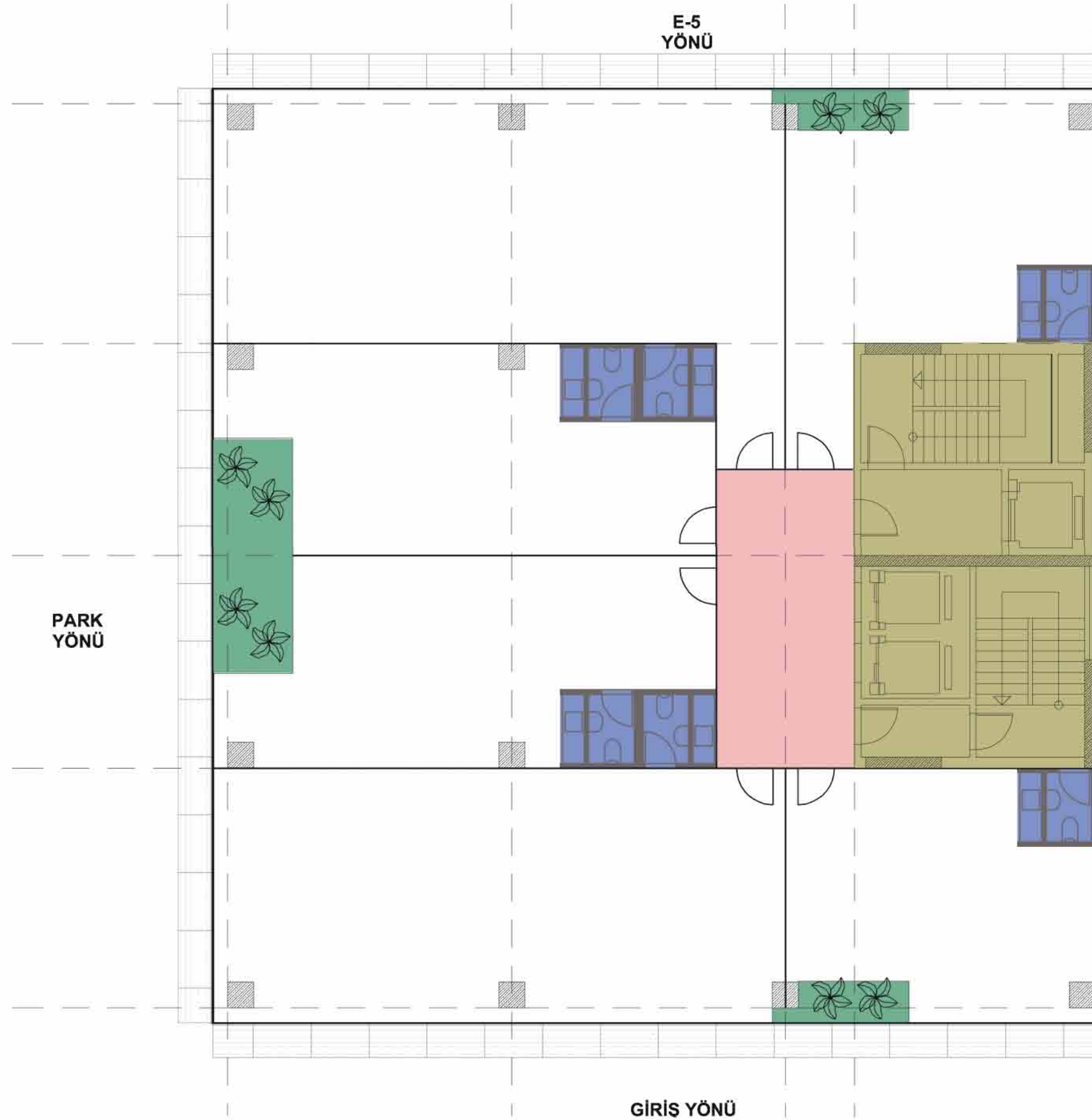

Islak hacim  
kat sirkülasyon  
duvarlar

DORE  
ARCHITECTS



METROPOLIST

6'lı ofis  
kat tipi

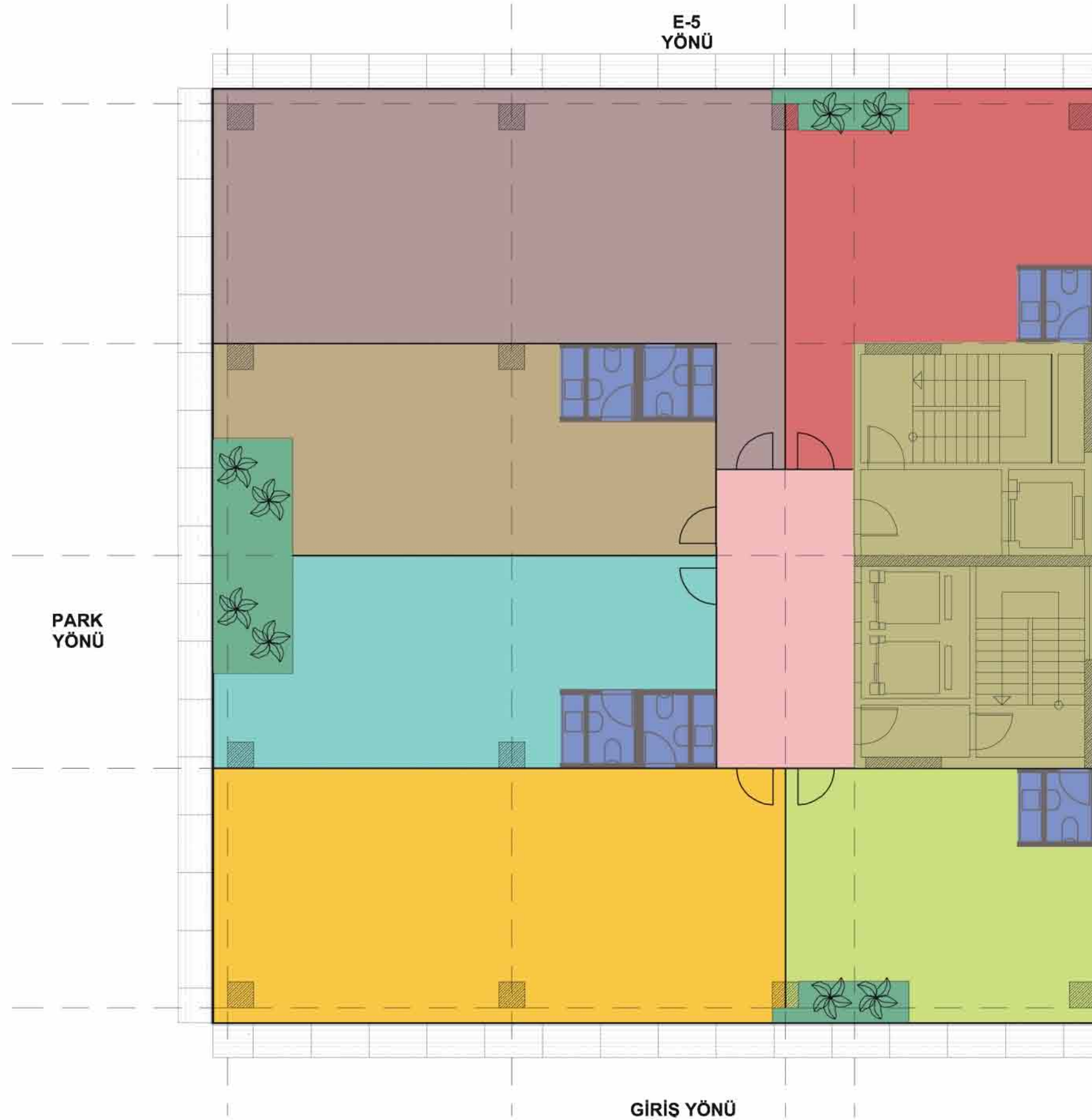

ofis tipleri  
Islak hacim  
kat sirkülasyon  
duvarlar

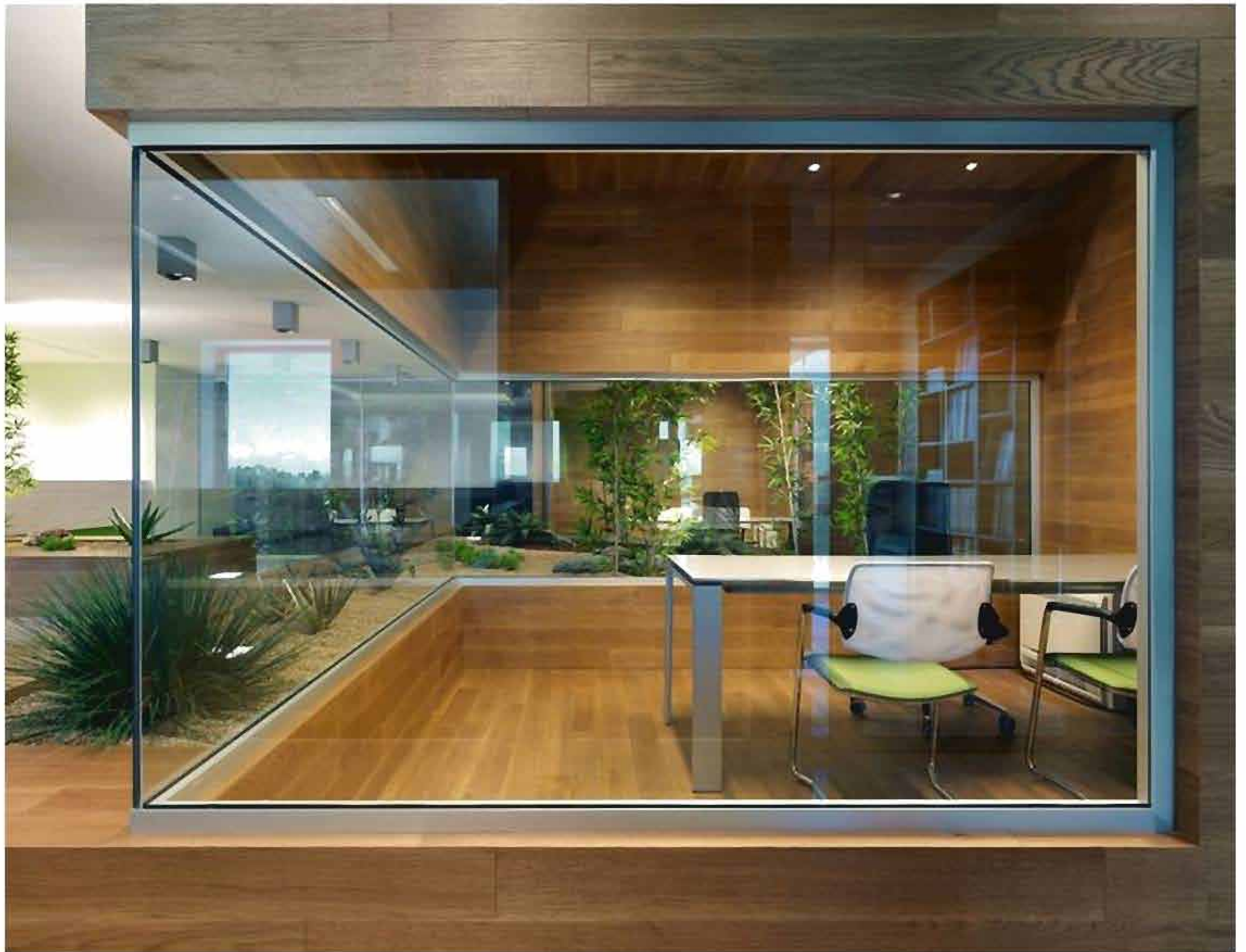



METROPOLIST

# ALTERNATİF KAT TIPLERİ

DORE  
ARCHITECTS



METROPOLIST

ALTERNATİF  
KAT TIPLERİ  
2'li ofis  
kat tipi

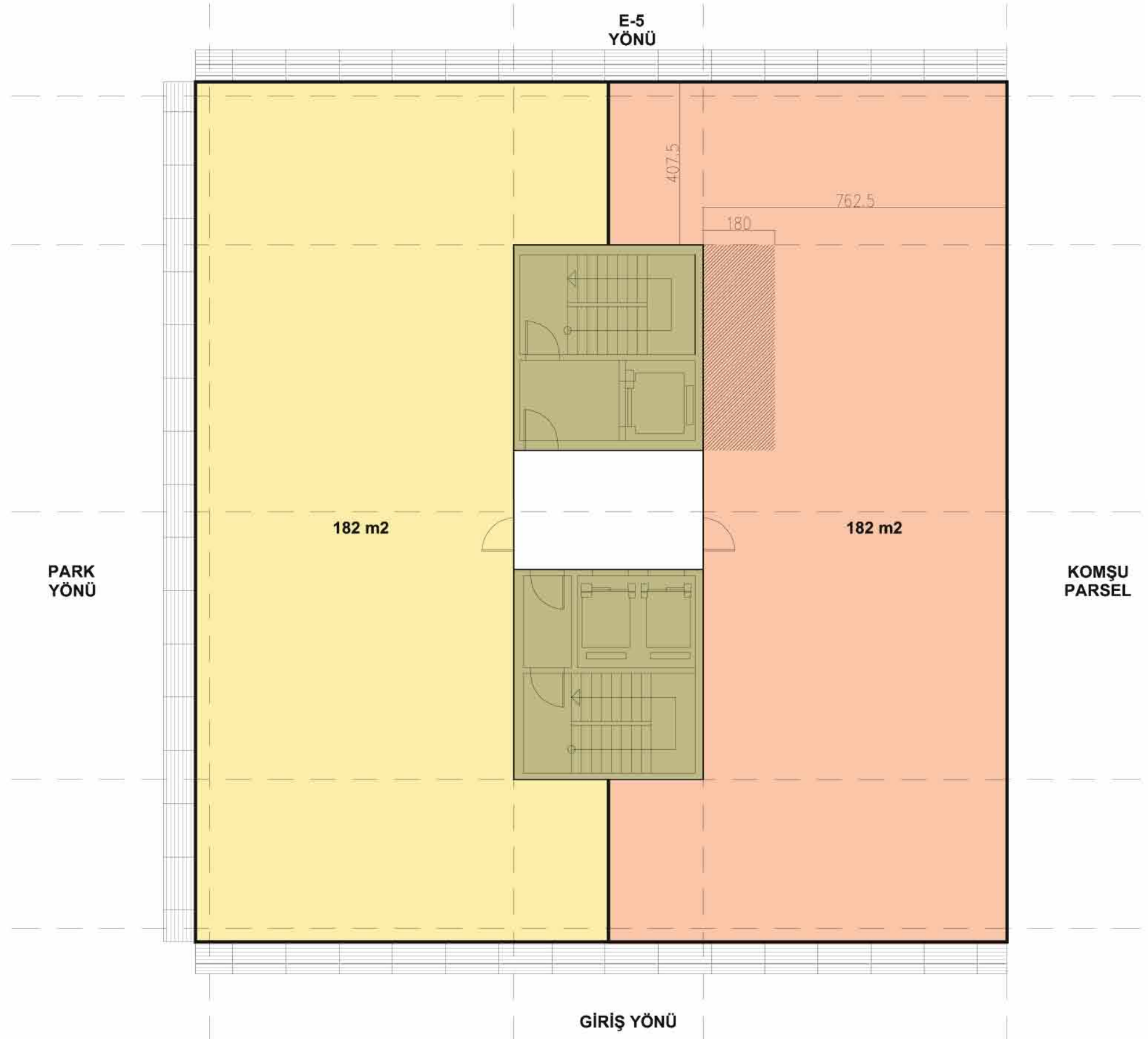

DORE  
ARCHITECTS





METROPOLIST

ALTERNATİF  
KAT TIPLERİ  
4'lü ofis  
kat tipi



DORE  
ARCHITECTS



METROPOLIST

ALTERNATİF  
KAT TIPLERİ  
6'lı ofis  
kat tipi





**METROPOLIST  
OFİS TİPLERİ**

**SIĞINAK**  
grup çalışması

**KOVAN**  
toplu mekanda  
bireysel çalışma

**HÜCRE**  
bireysel izole  
çalışma



**METROPOLIST  
OFİS TİPLERİ**

**SIĞINAK**  
grup çalışması

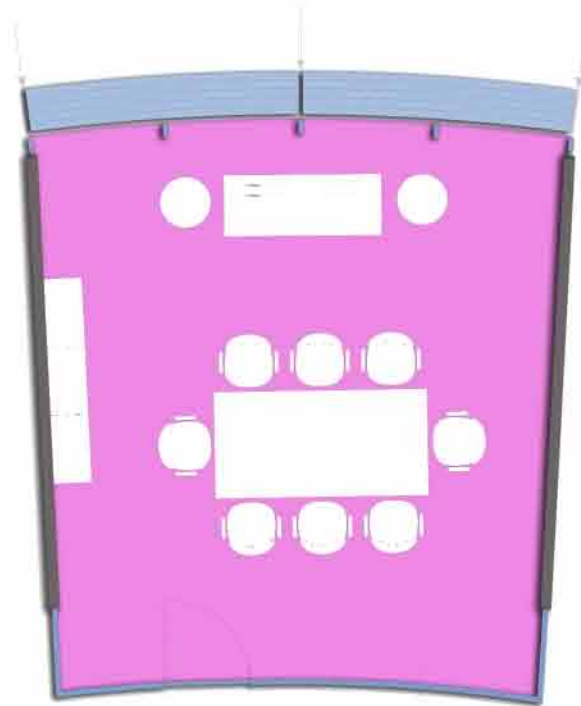

**KOVAN**  
toplu mekanda  
bireysel çalışma

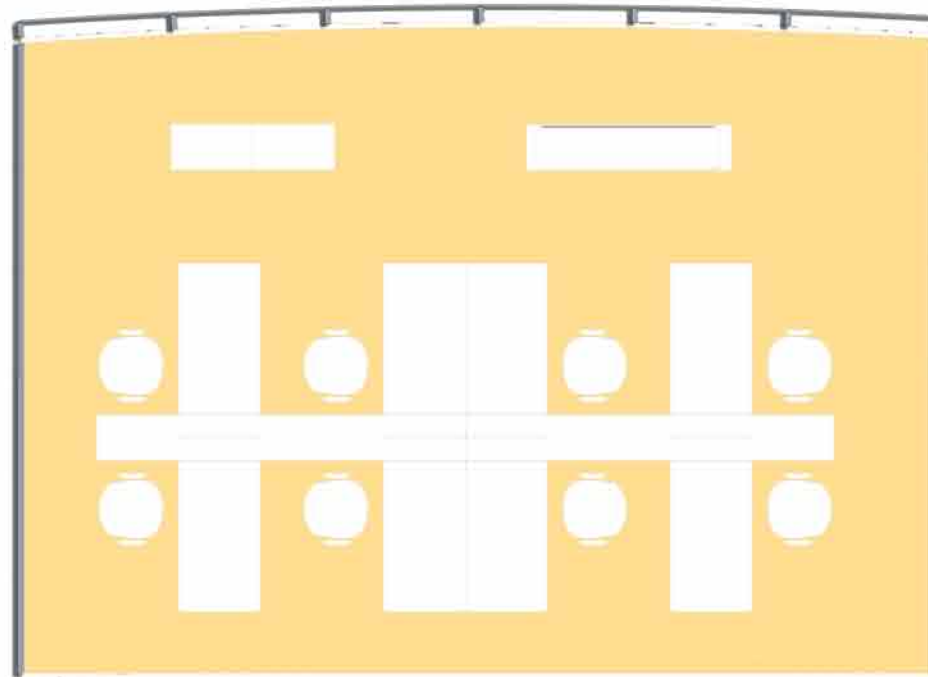

**HÜCRE**  
bireysel izole  
çalışma

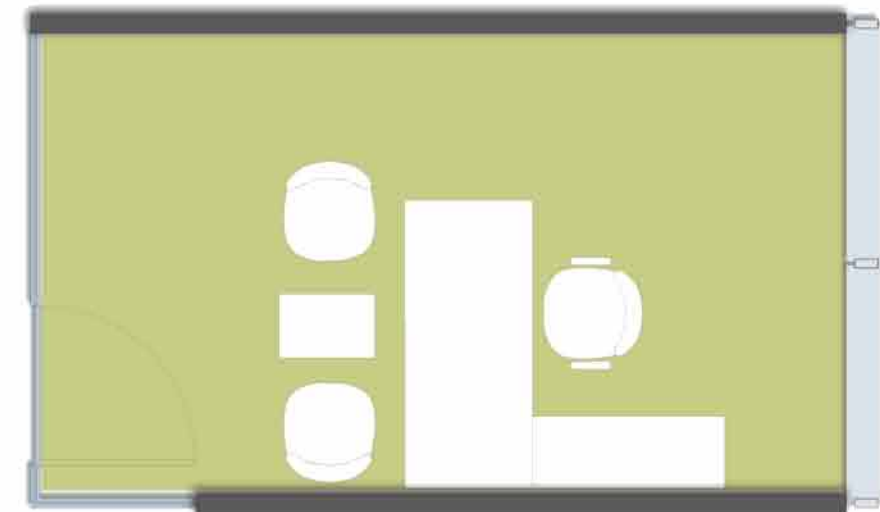



**METROPOLIST**  
**ISLAK HACİM**  
**TIPLERİ**

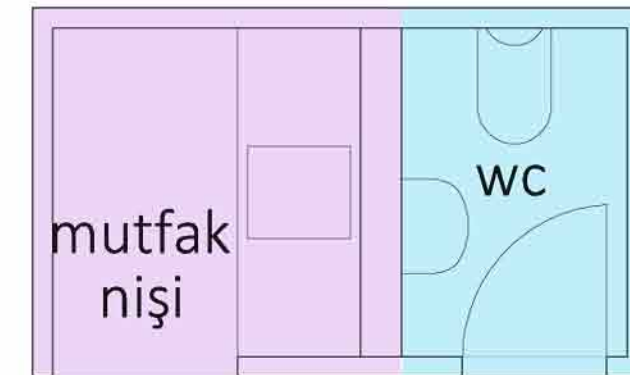
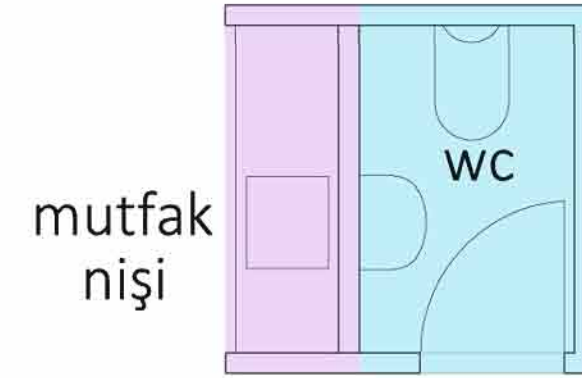
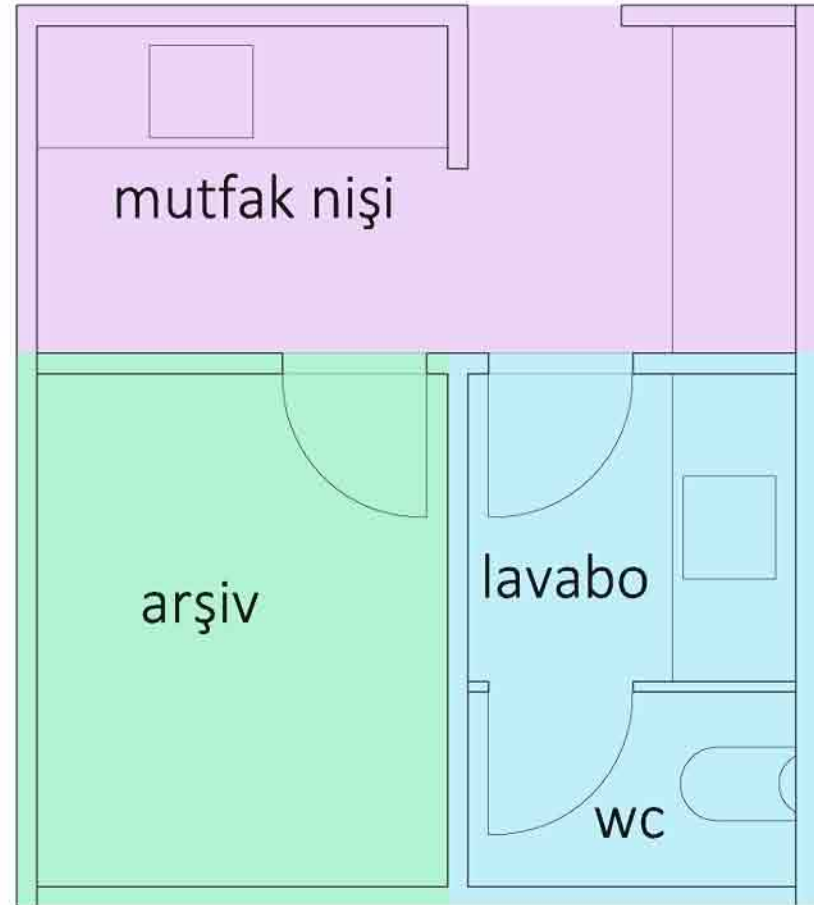
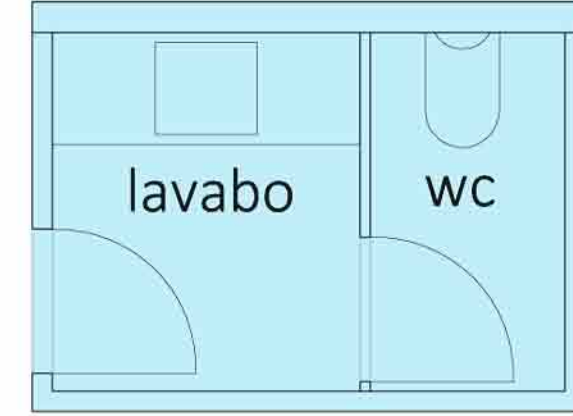
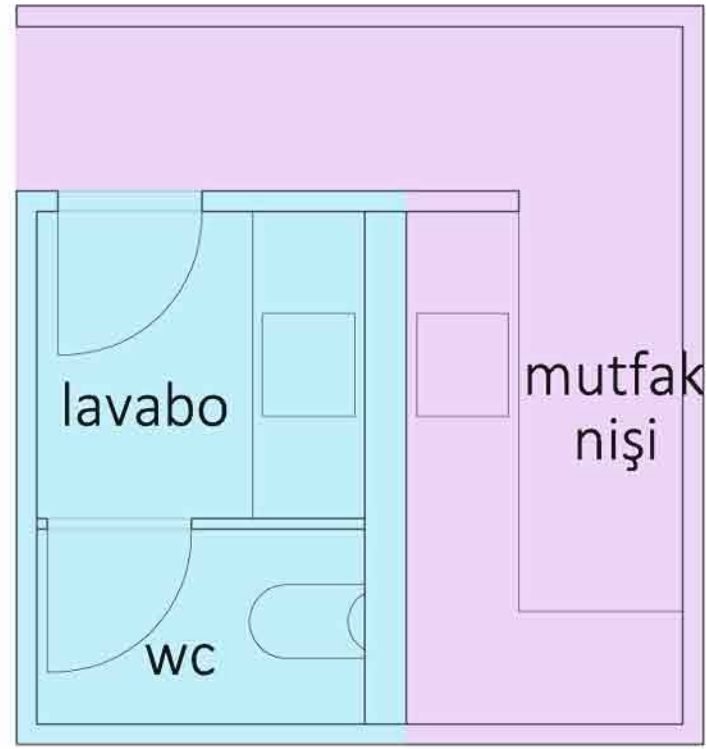



METROPOLIST

# STATİK ÖNERİ

**DORE**  
ARCHITECTS



METROPOLIST

STATİK  
ÇÖZÜM  
ÖNERİSİ

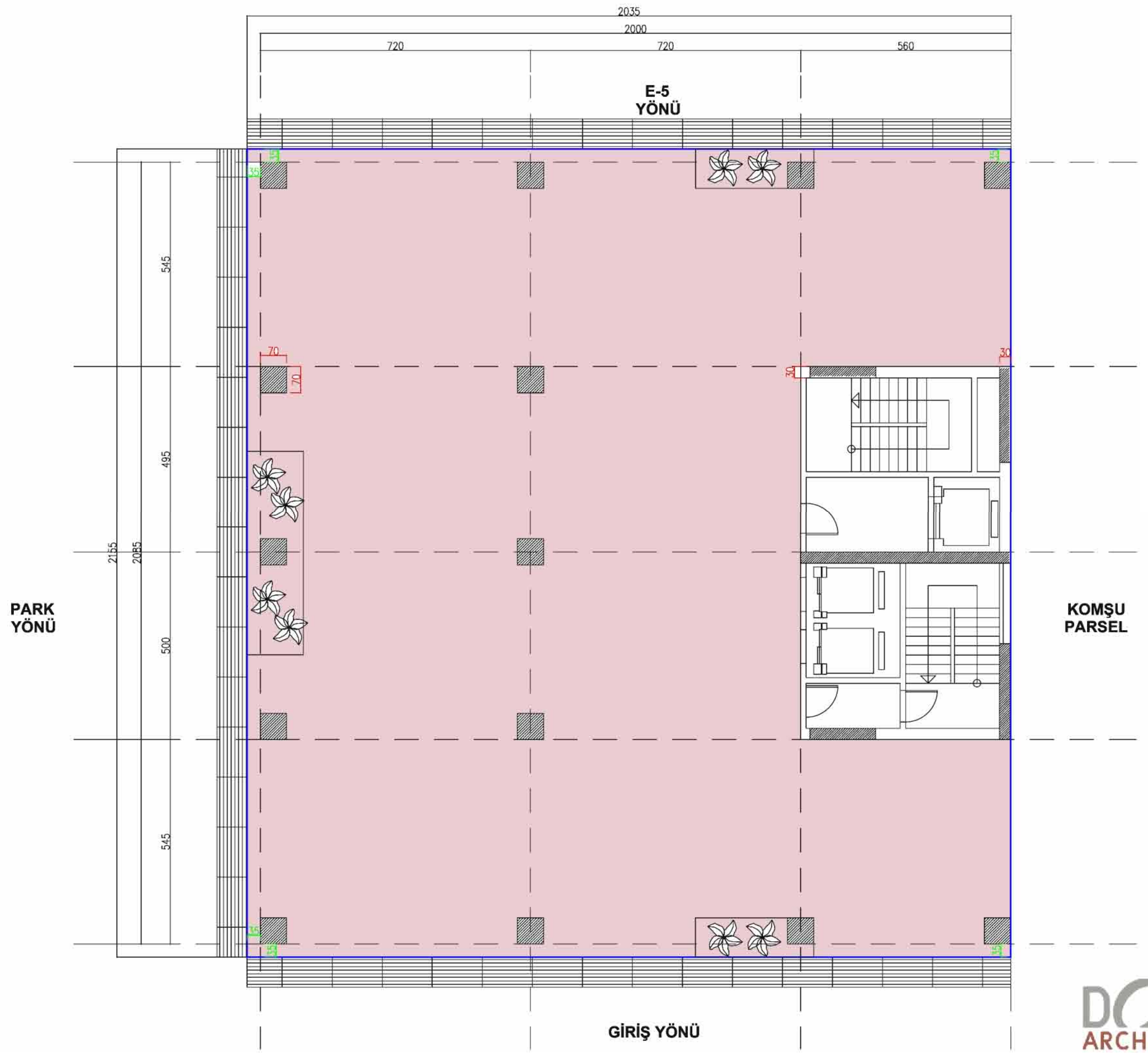

DORE  
ARCHITECTS



MEKANI NASIL KULLANMAK ISTIYORUZ?







METROPOLIST

# iÇ MİMARİ

DORE  
ARCHITECTS



METROPOLIST



DORE  
ARCHITECTS



METROPOLIST

3'lü Ofis planı  
Alternatif  
Ofis

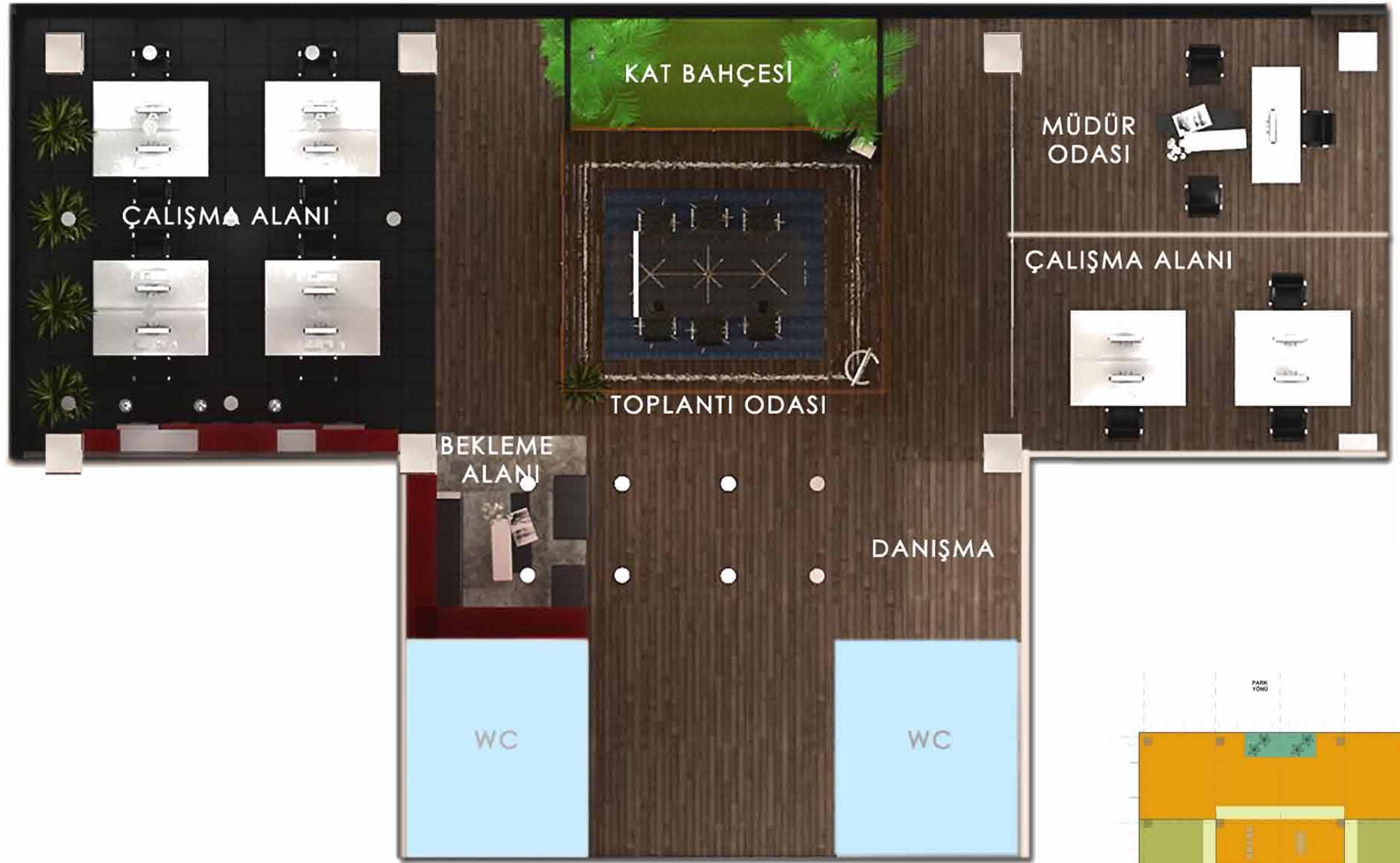

3'lü Ofis Kat tipi



METROPOLIST



DORE

DORE  
ARCHITECTS



METROPOLIST

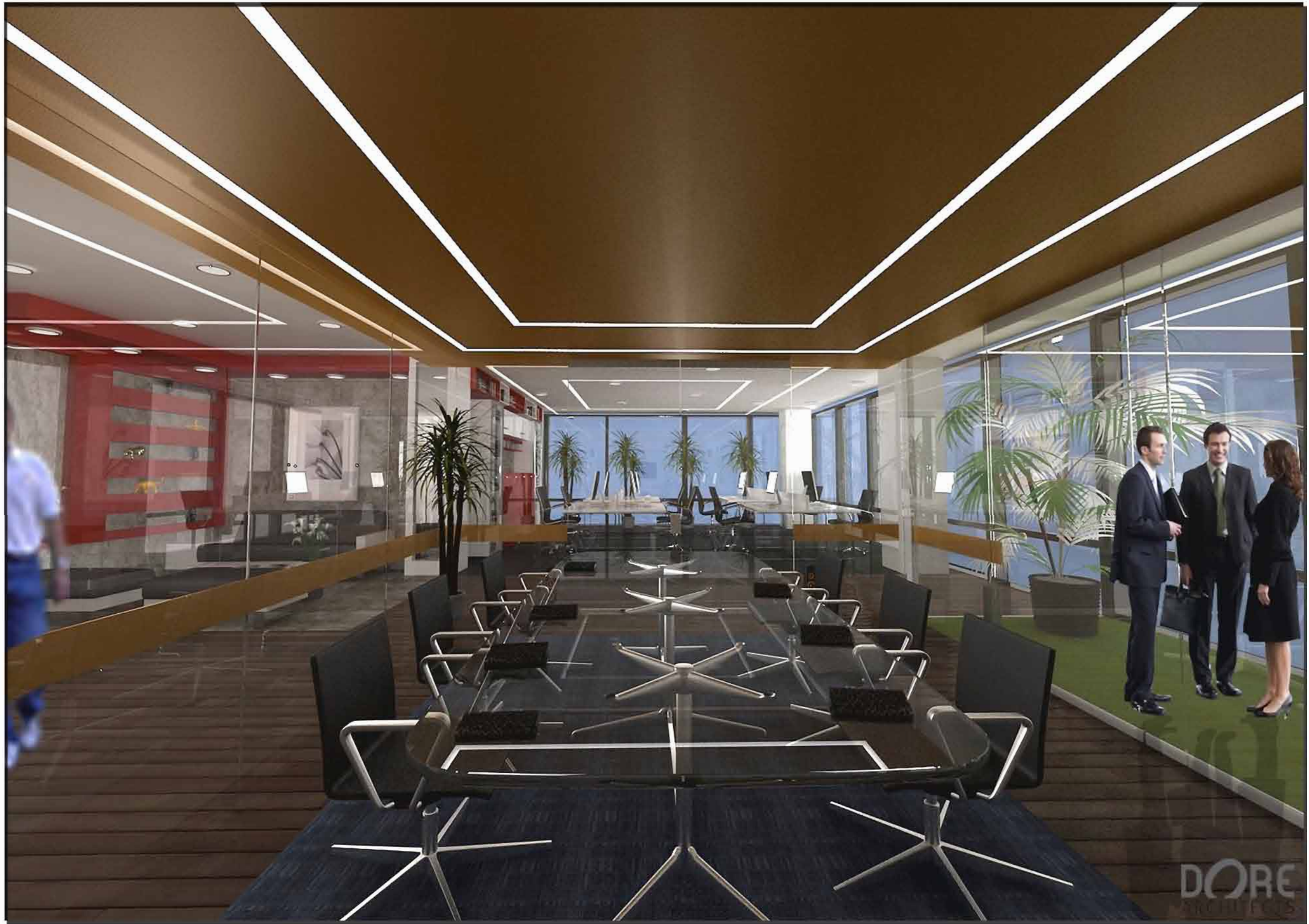

DORE  
ARCHITECTS

DORE  
ARCHITECTS



METROPOLIST

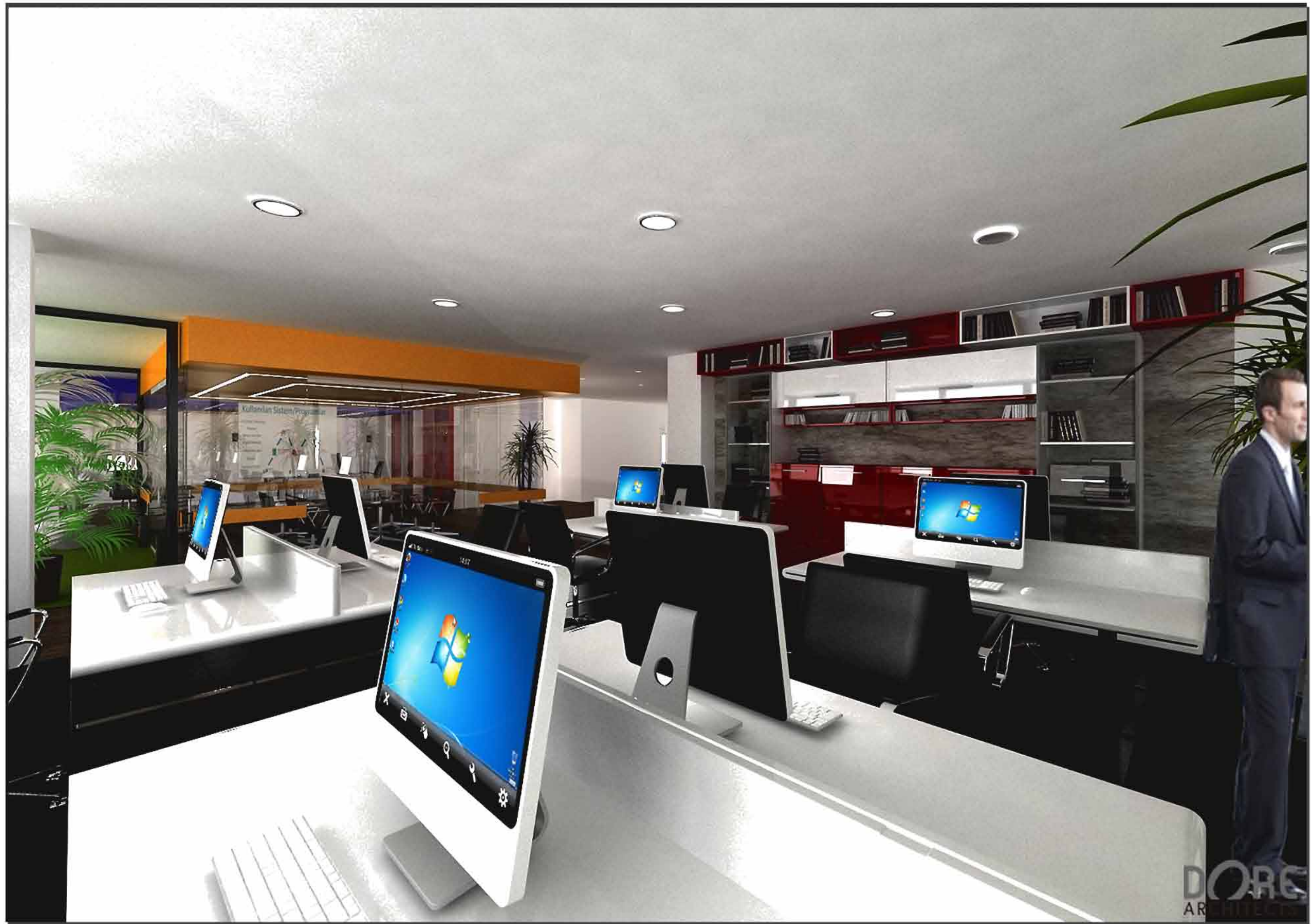

DORE  
ARCHITECTS

DORE  
ARCHITECTS



METROPOLIST



DORE

DORE  
ARCHITECTS





METROPOLIST

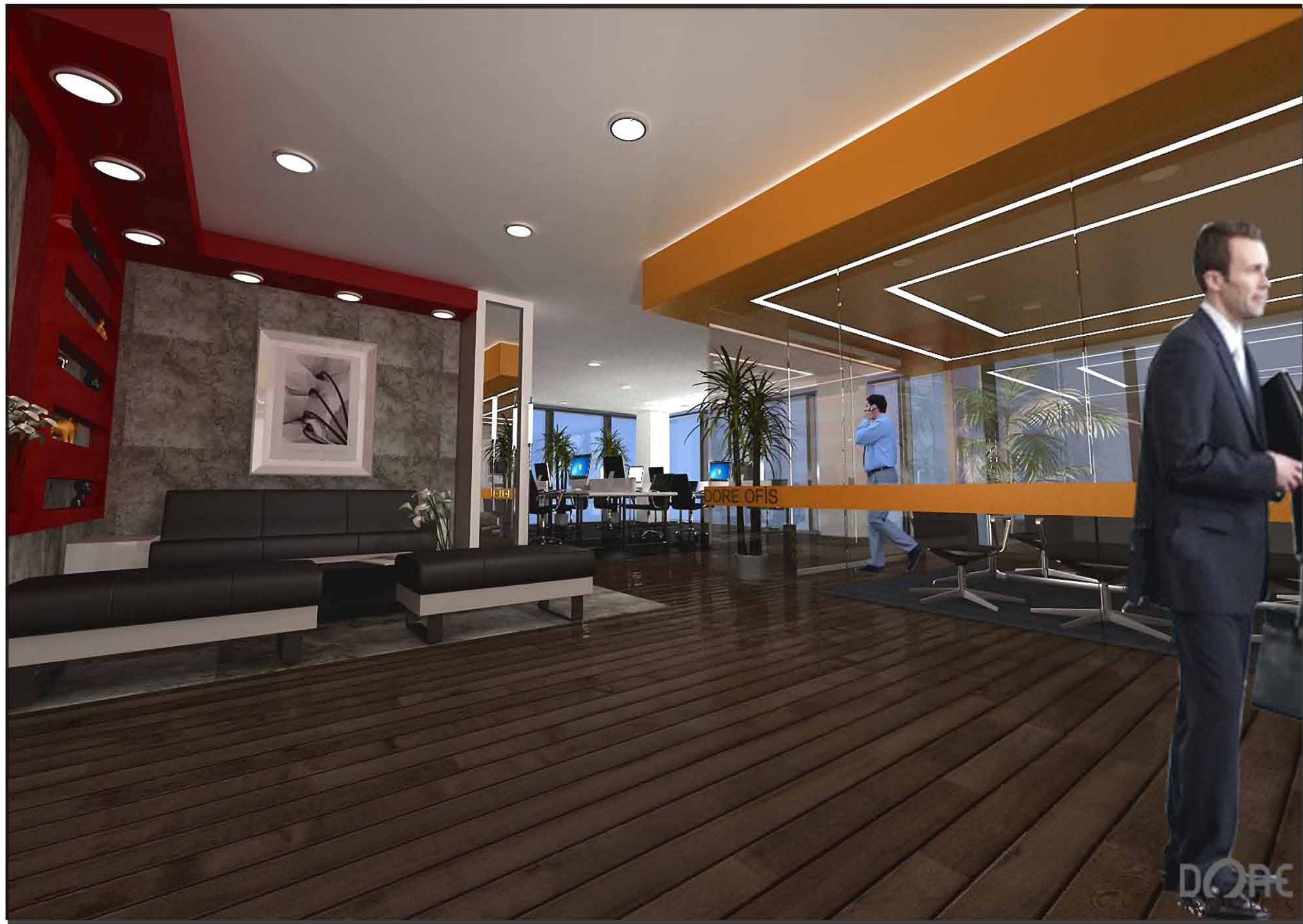

DORE

DORE  
ARCHITECTS



METROPOLIST

# GÖLGELENME ANALIZI

**DORE**  
ARCHITECTS



METROPOLIST

GÖLGELENME  
ANALİZİ  
MART

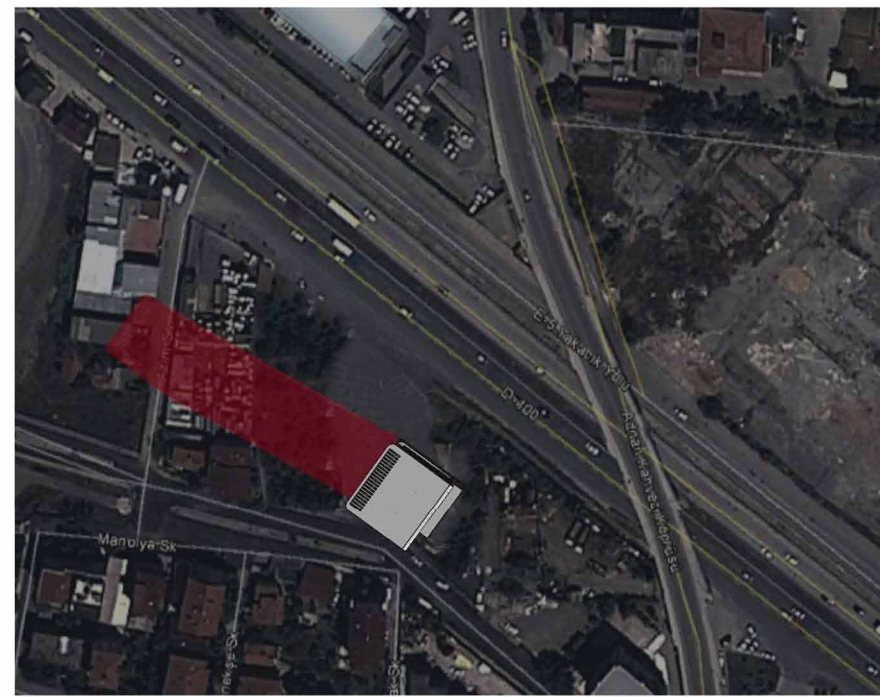
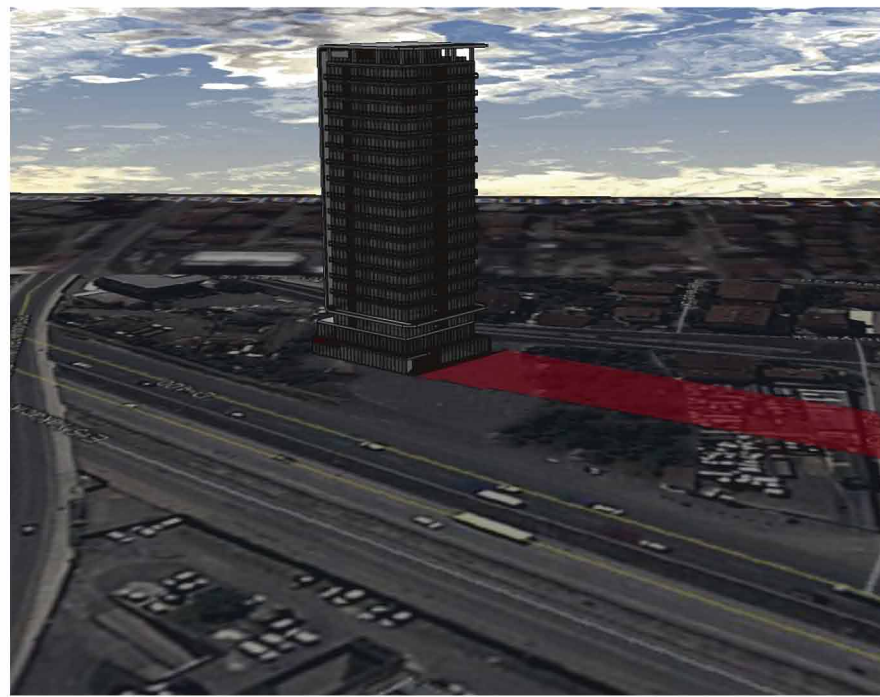

09:00

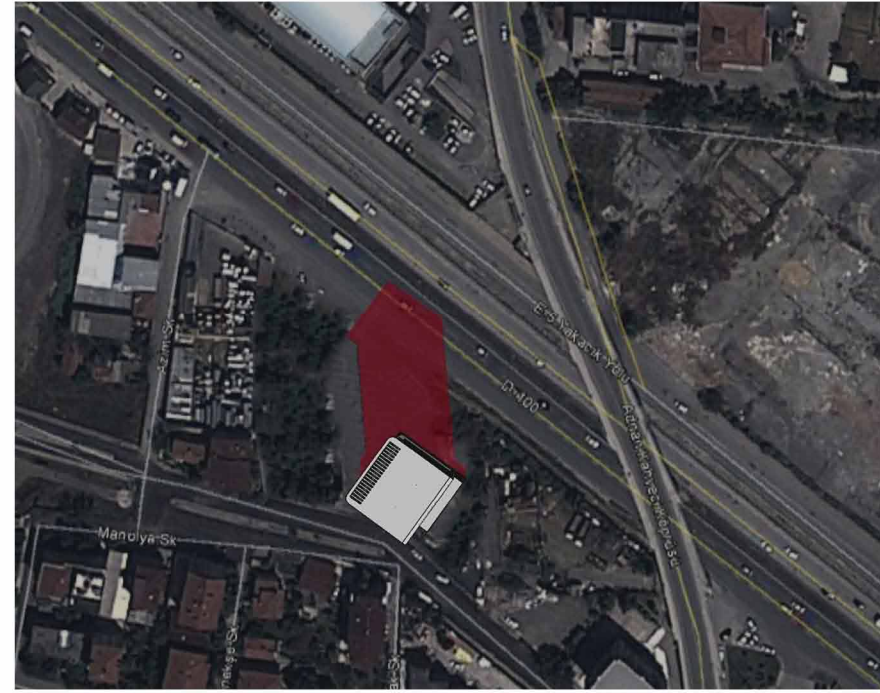
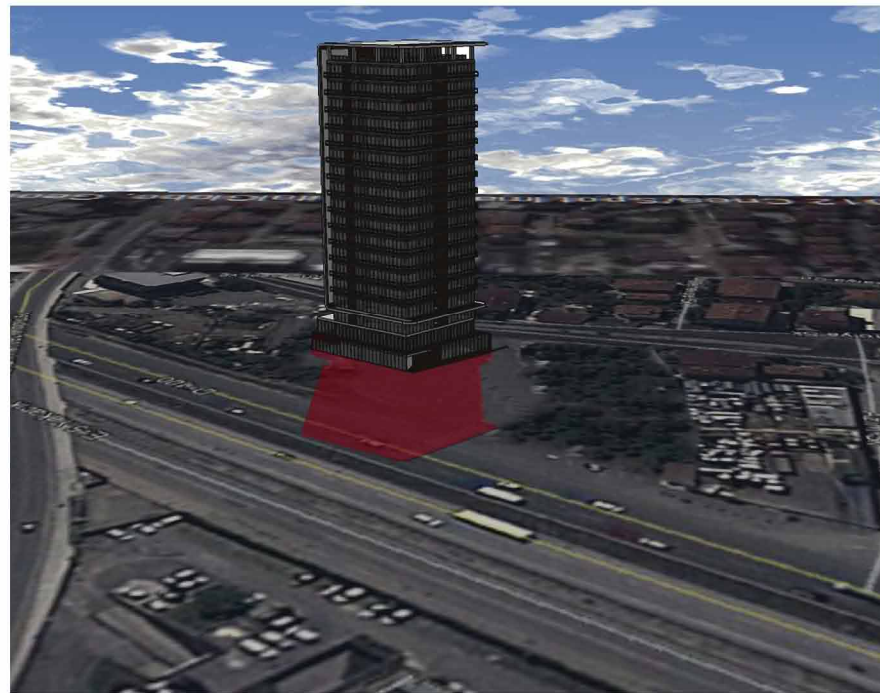

12:00

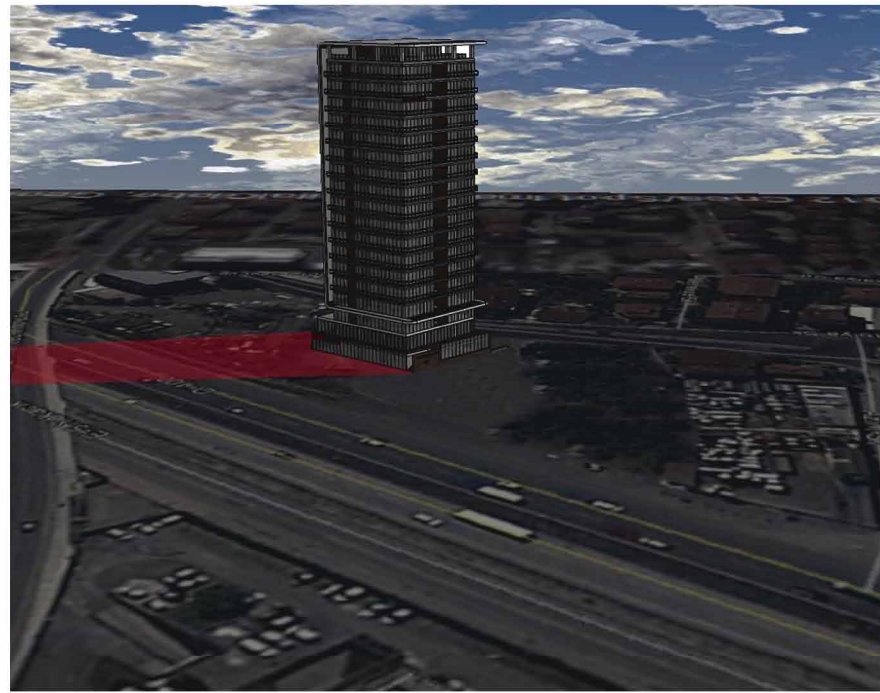

17:00



METROPOLIST

GÖLGELENME  
ANALİZİ  
HAZİRAN

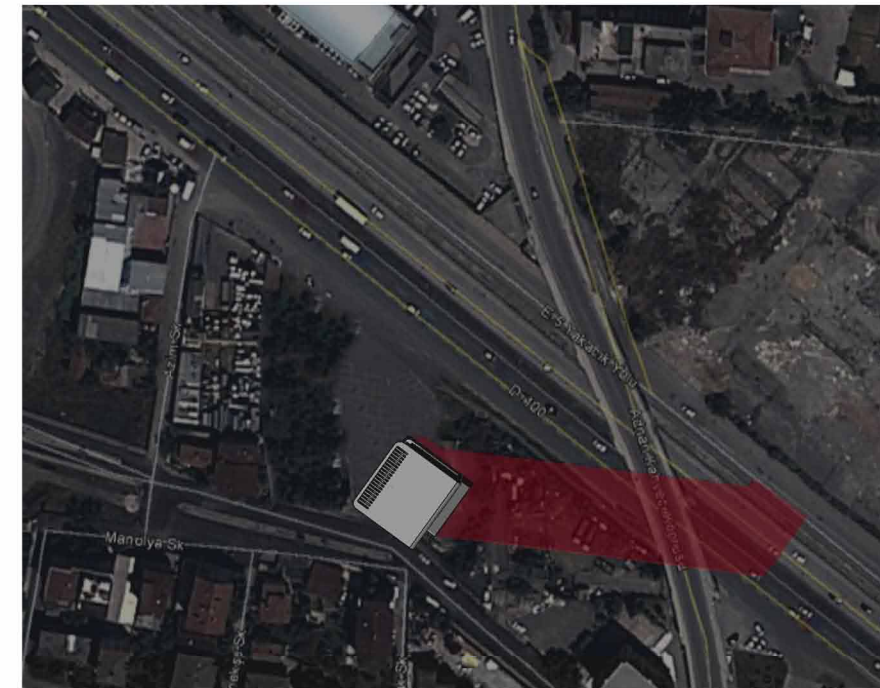
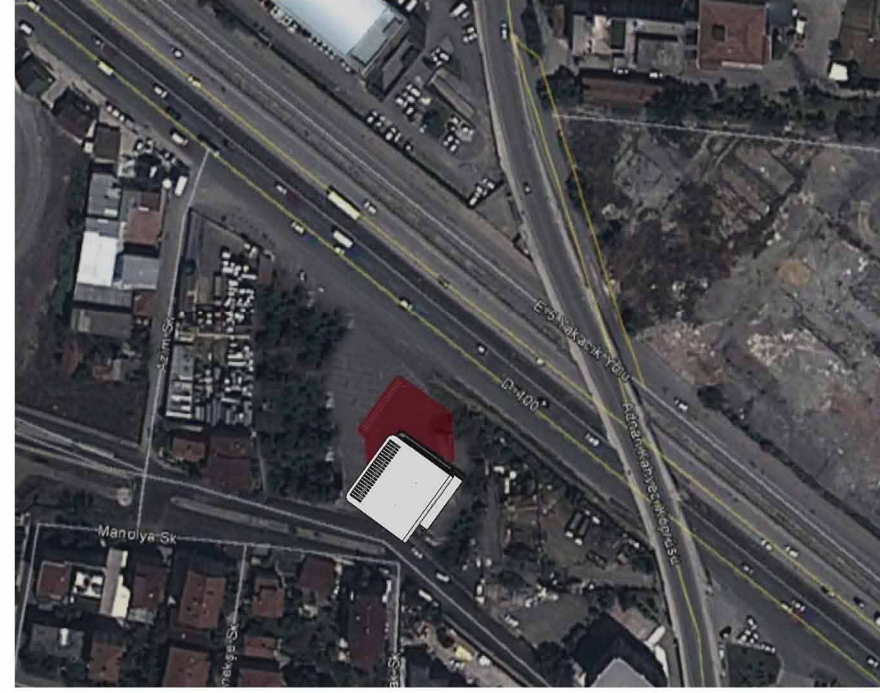
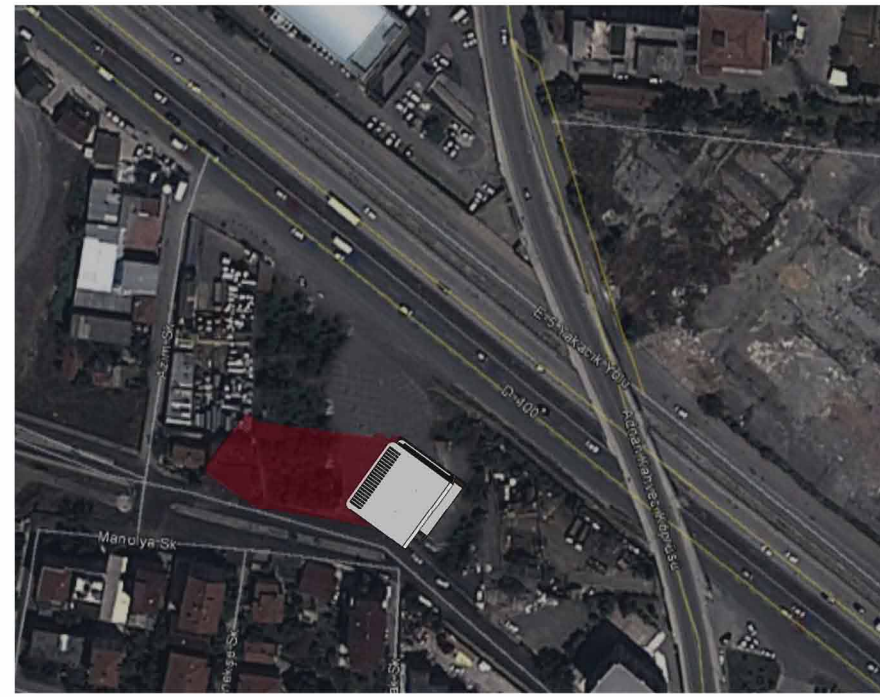
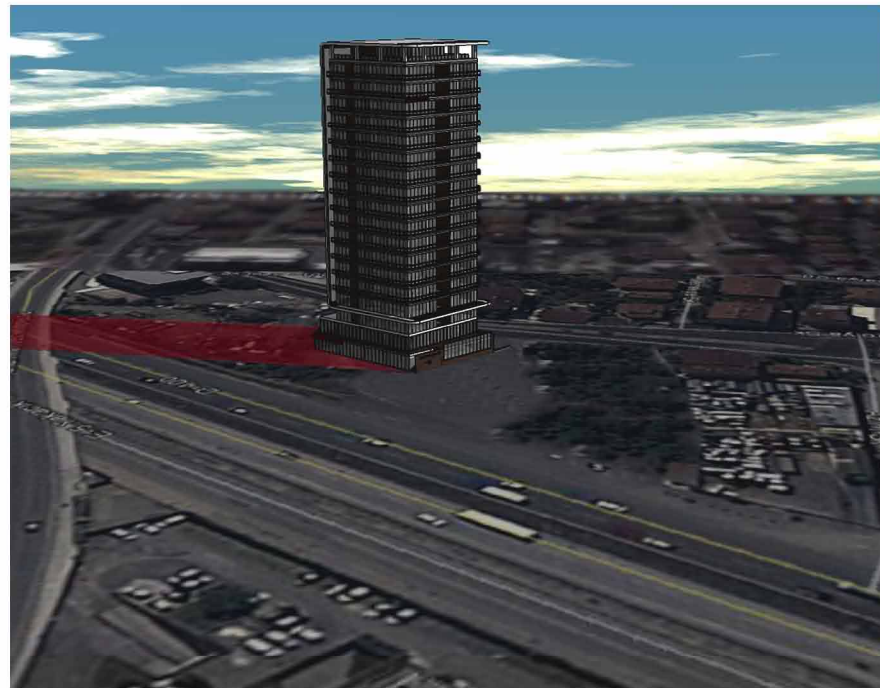
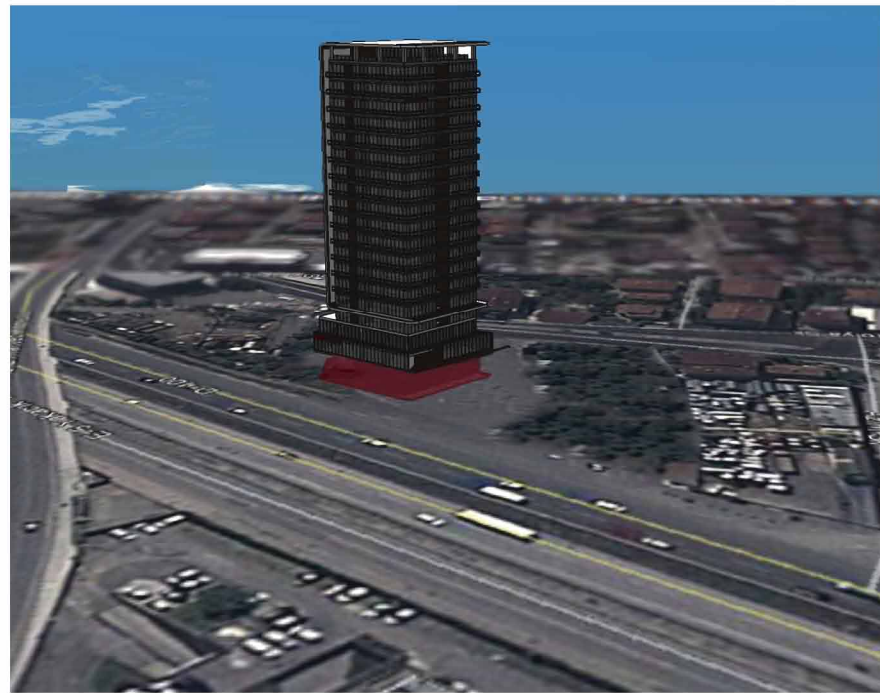
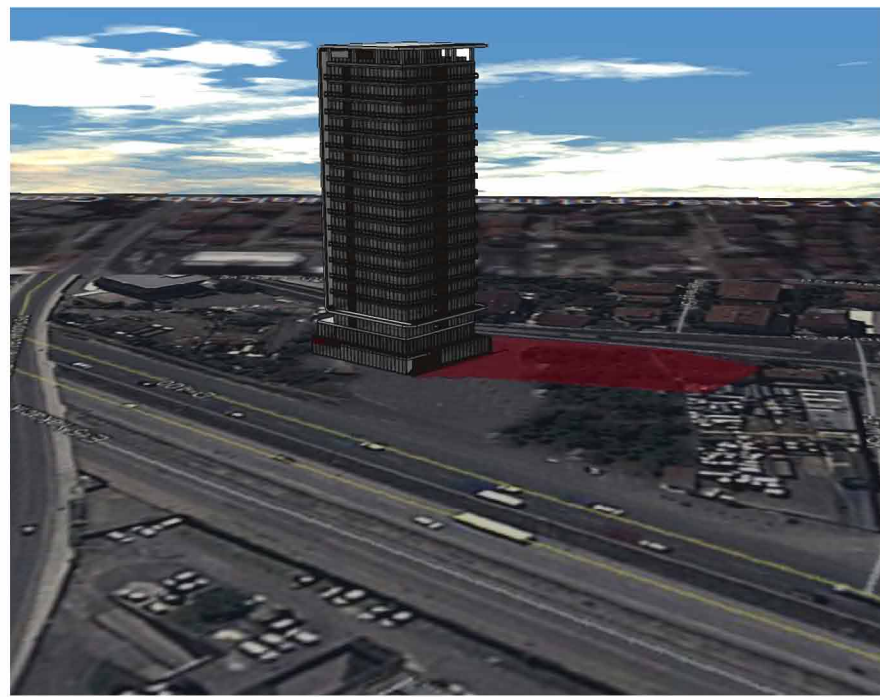

09:00

12:00

17:00



METROPOLIST

GÖLGELENME  
ANALİZİ  
EYLÜL

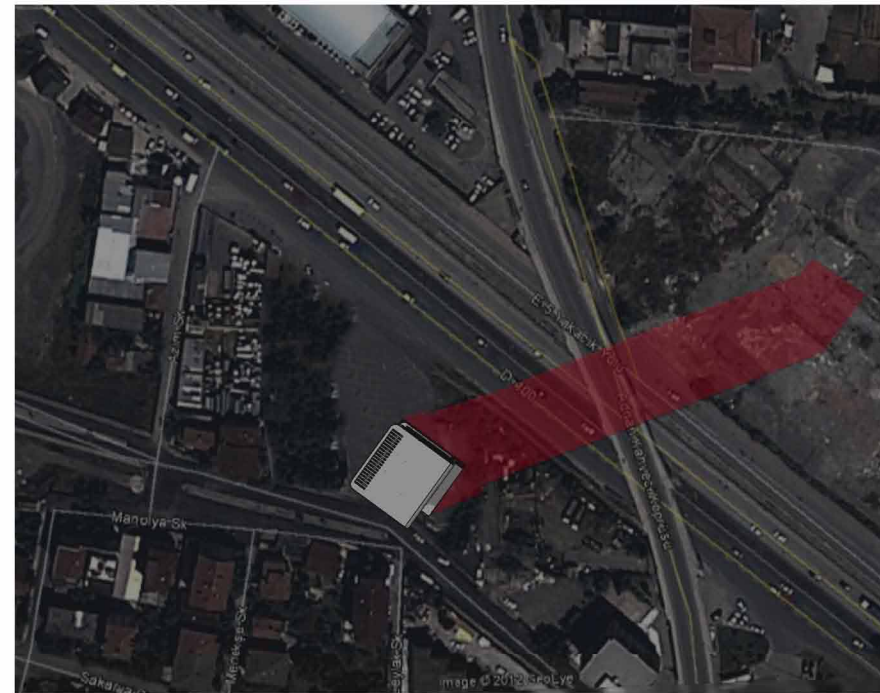
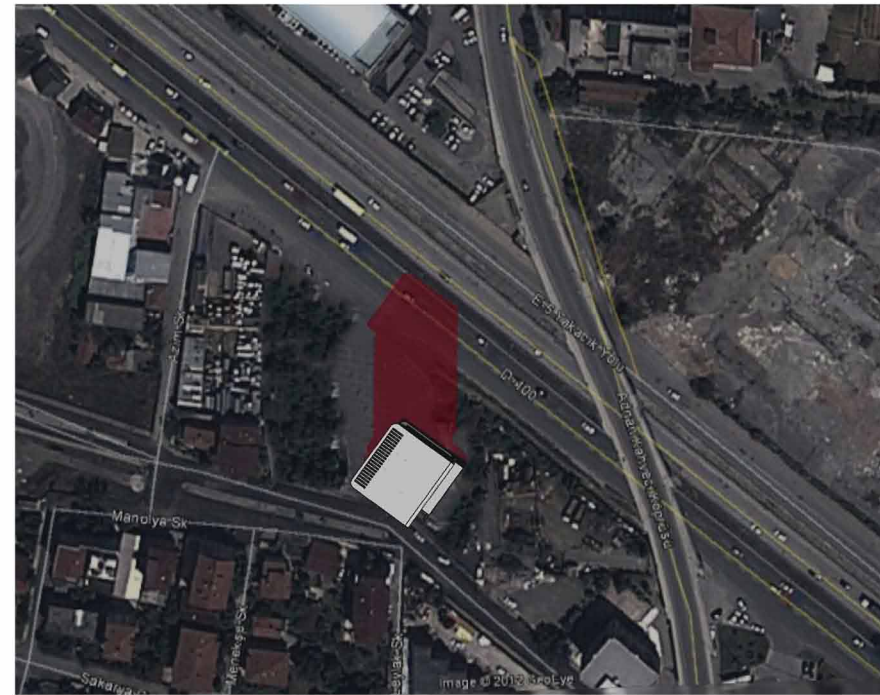
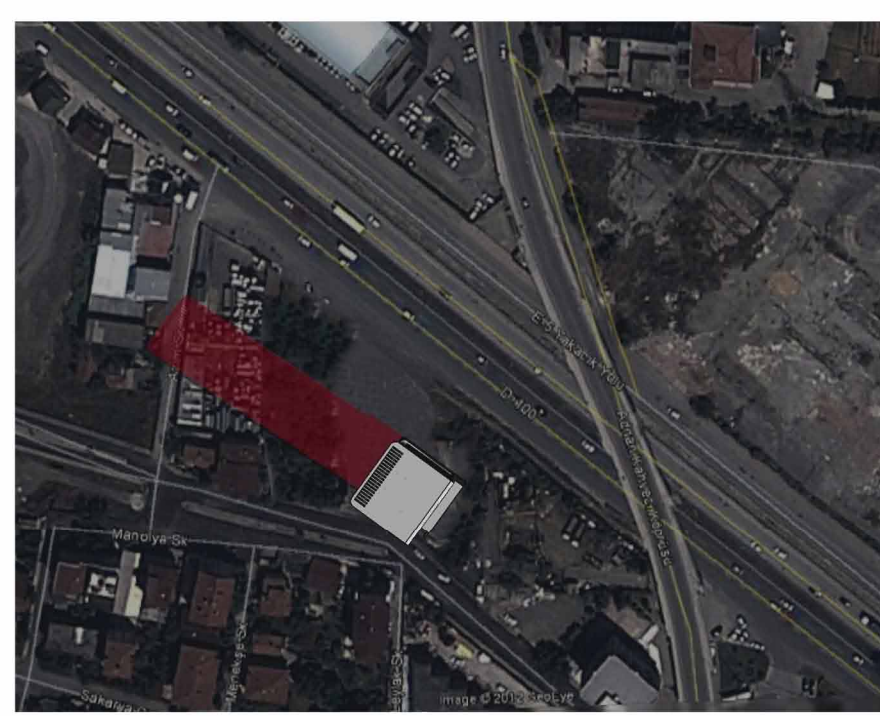
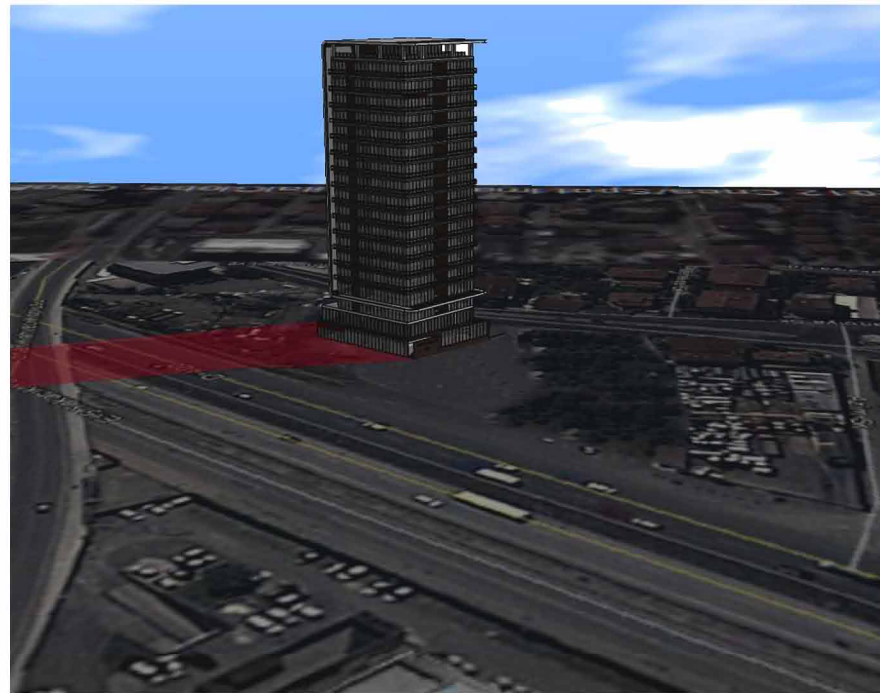
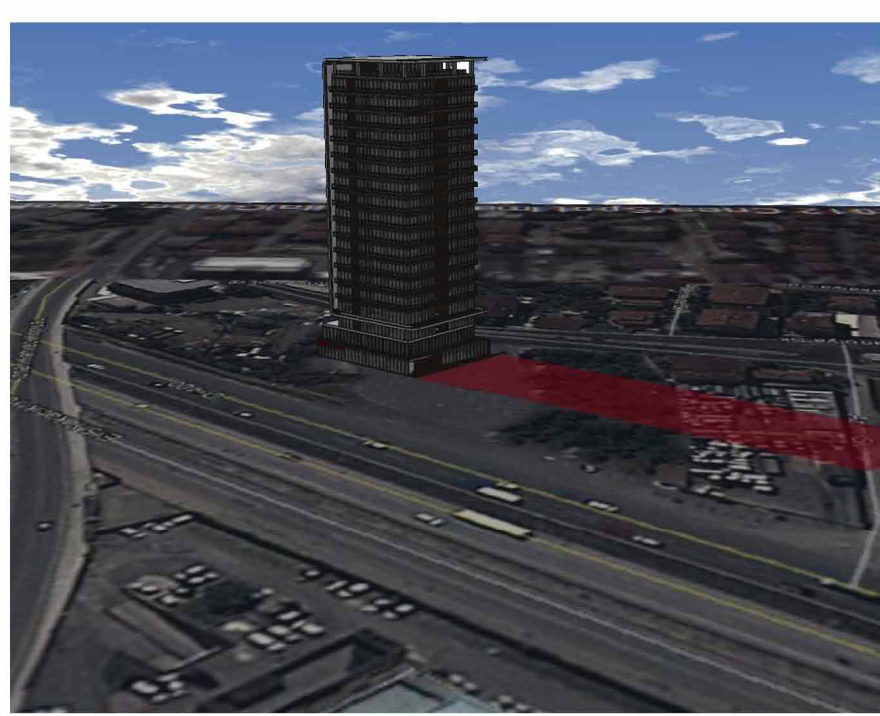

09:00

12:00

17:00



METROPOLIST

GÖLGELENME  
ANALİZİ  
ARALIK

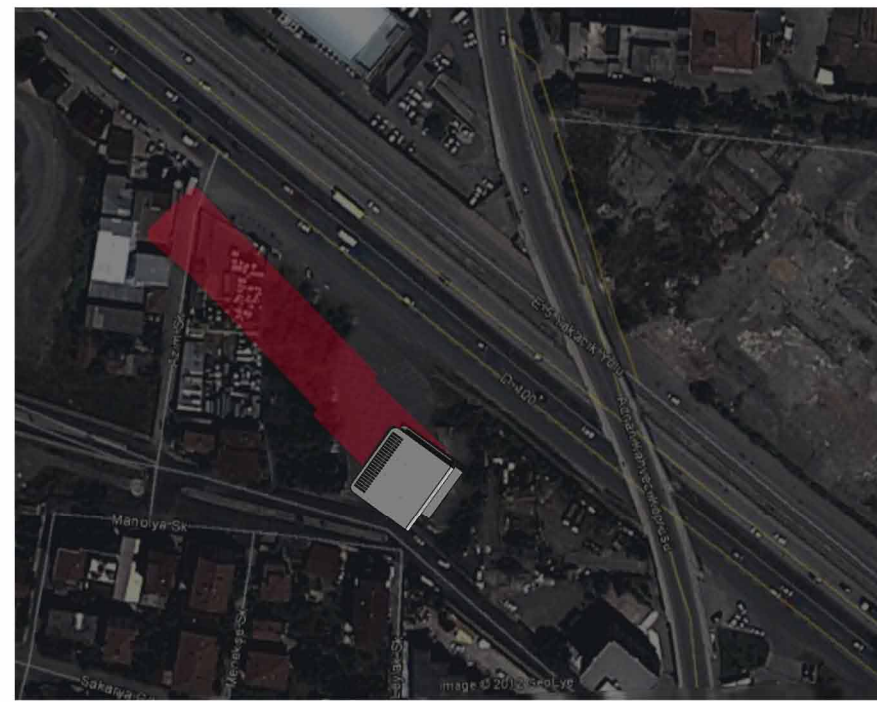
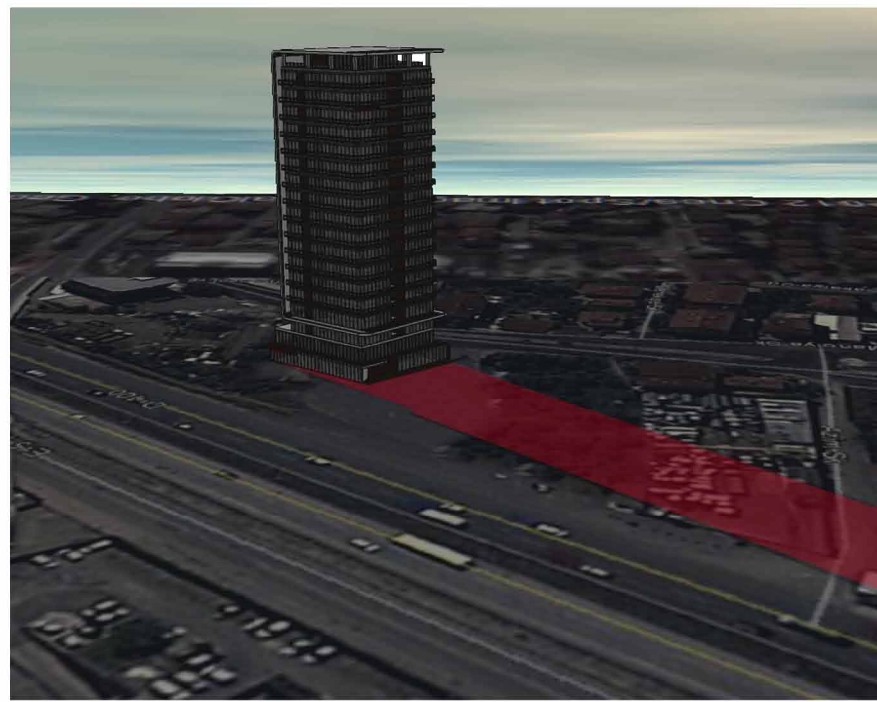

09:00

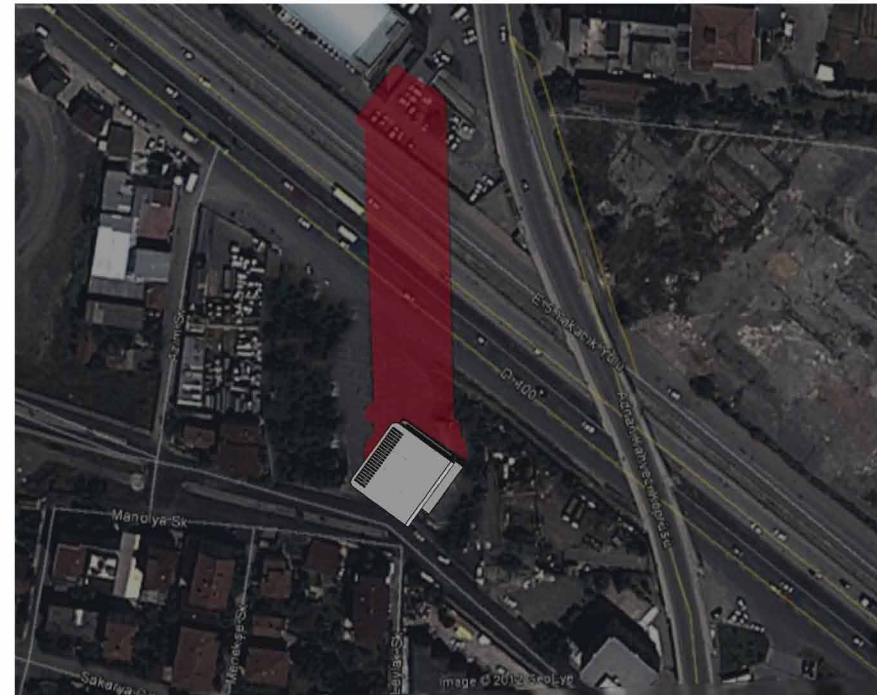
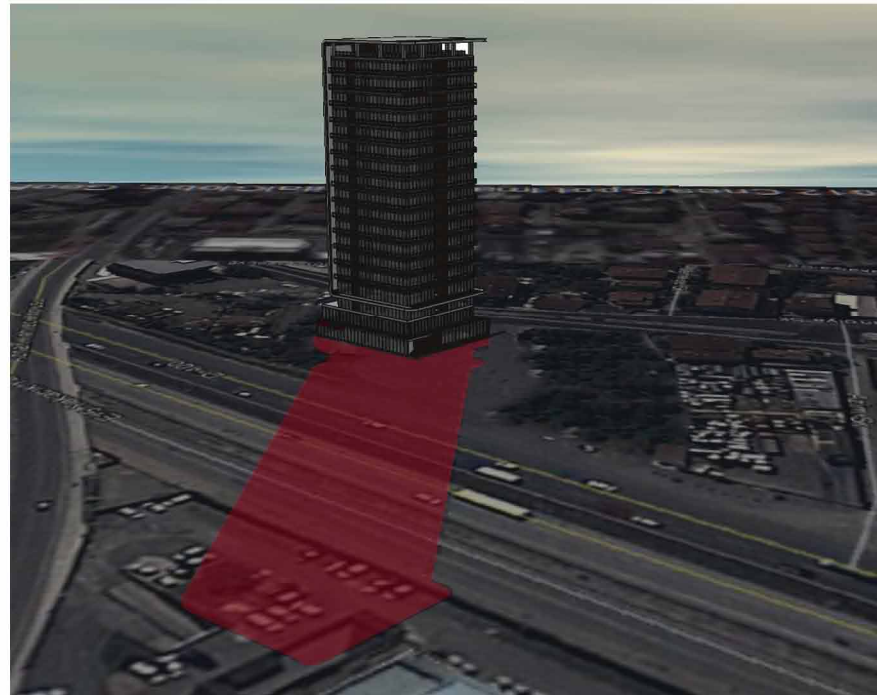

12:00

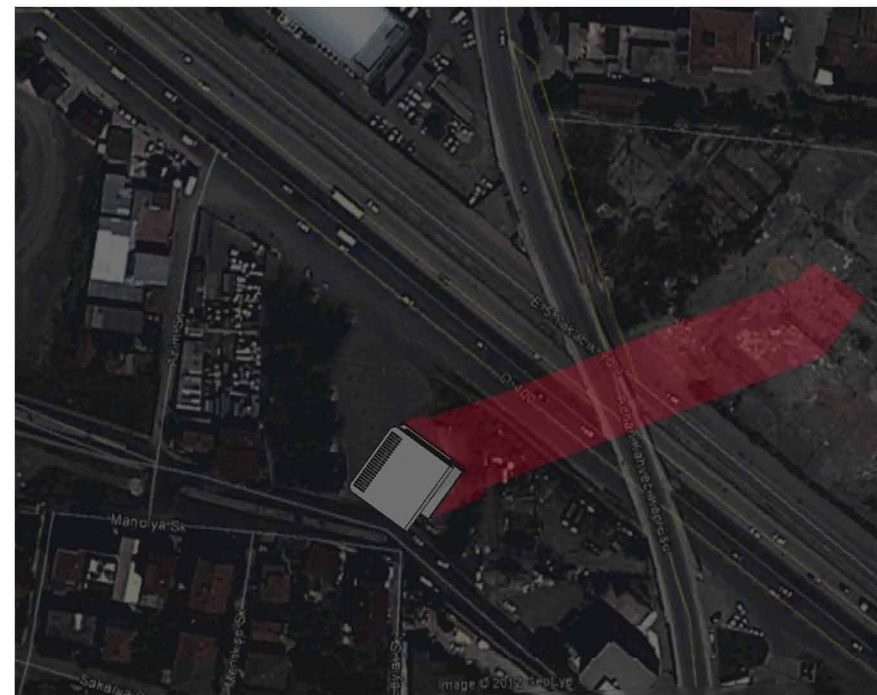
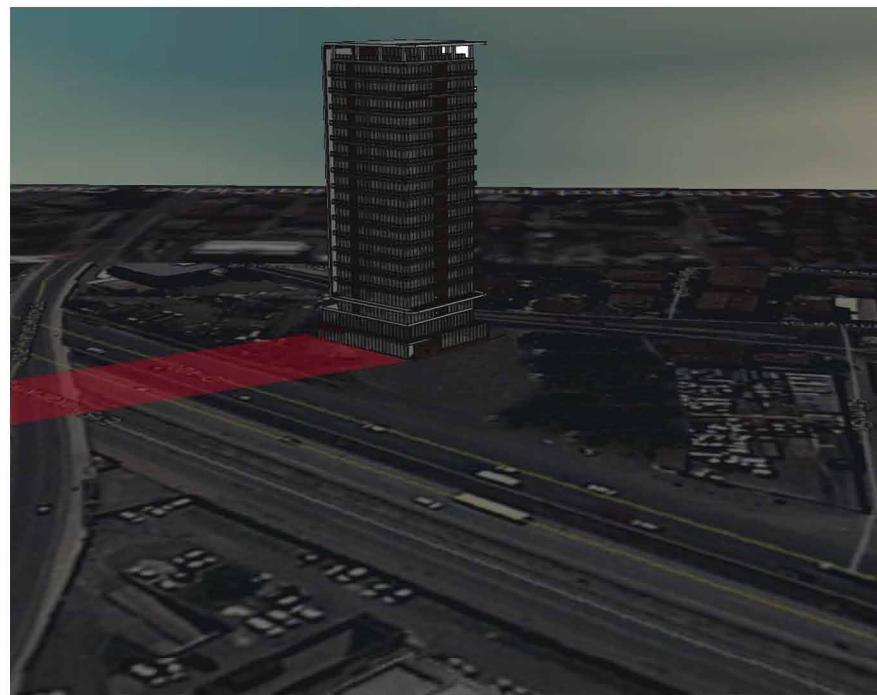

17:00



METROPOLIST

# DETAYLAR

**DORE**  
ARCHITECTS







METROPOLIST

# CEPHE AYDINLATMA DETAYI

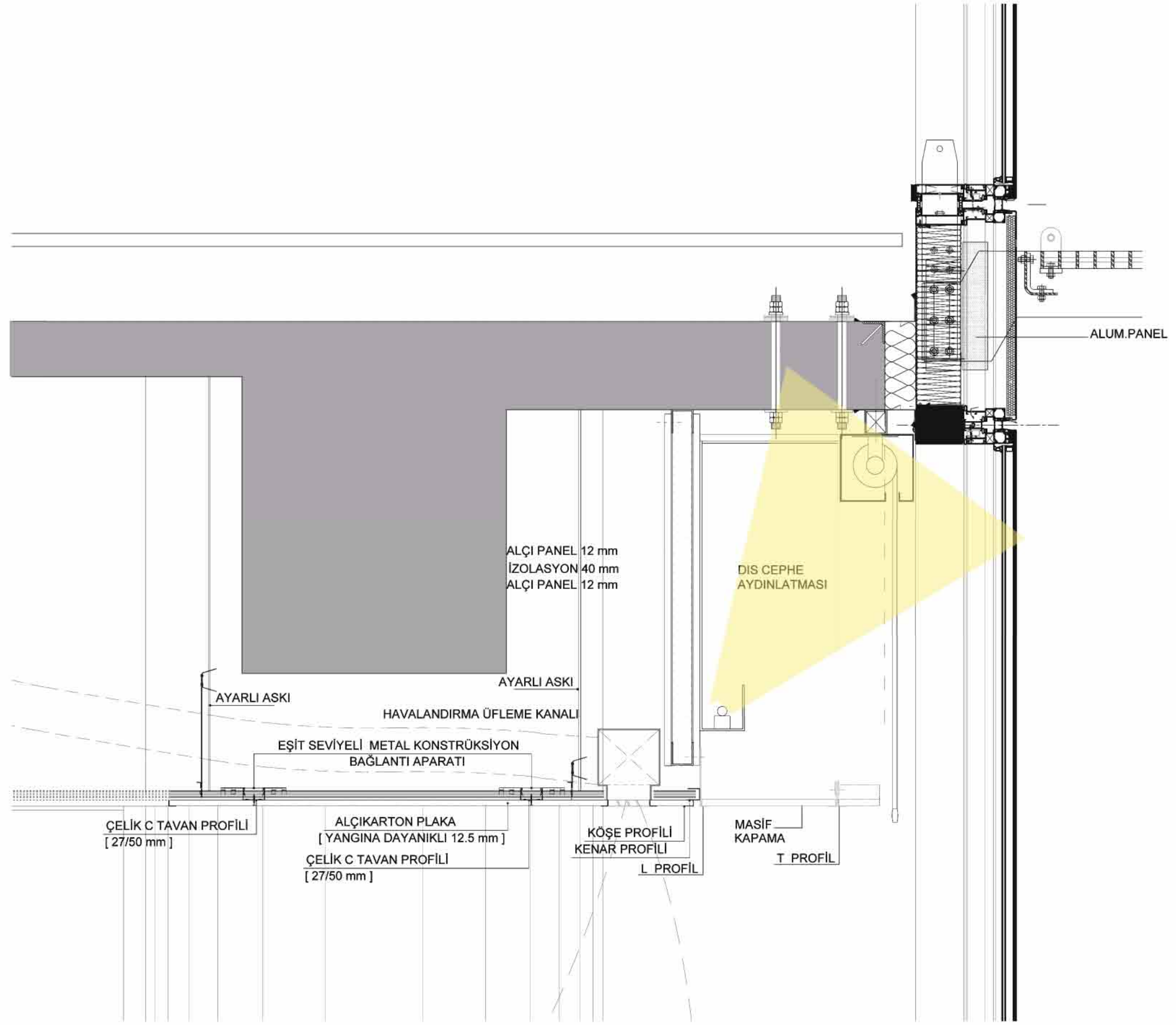





METROPOLIST

# CEPHE GÖLGELENDİRME DETAYI

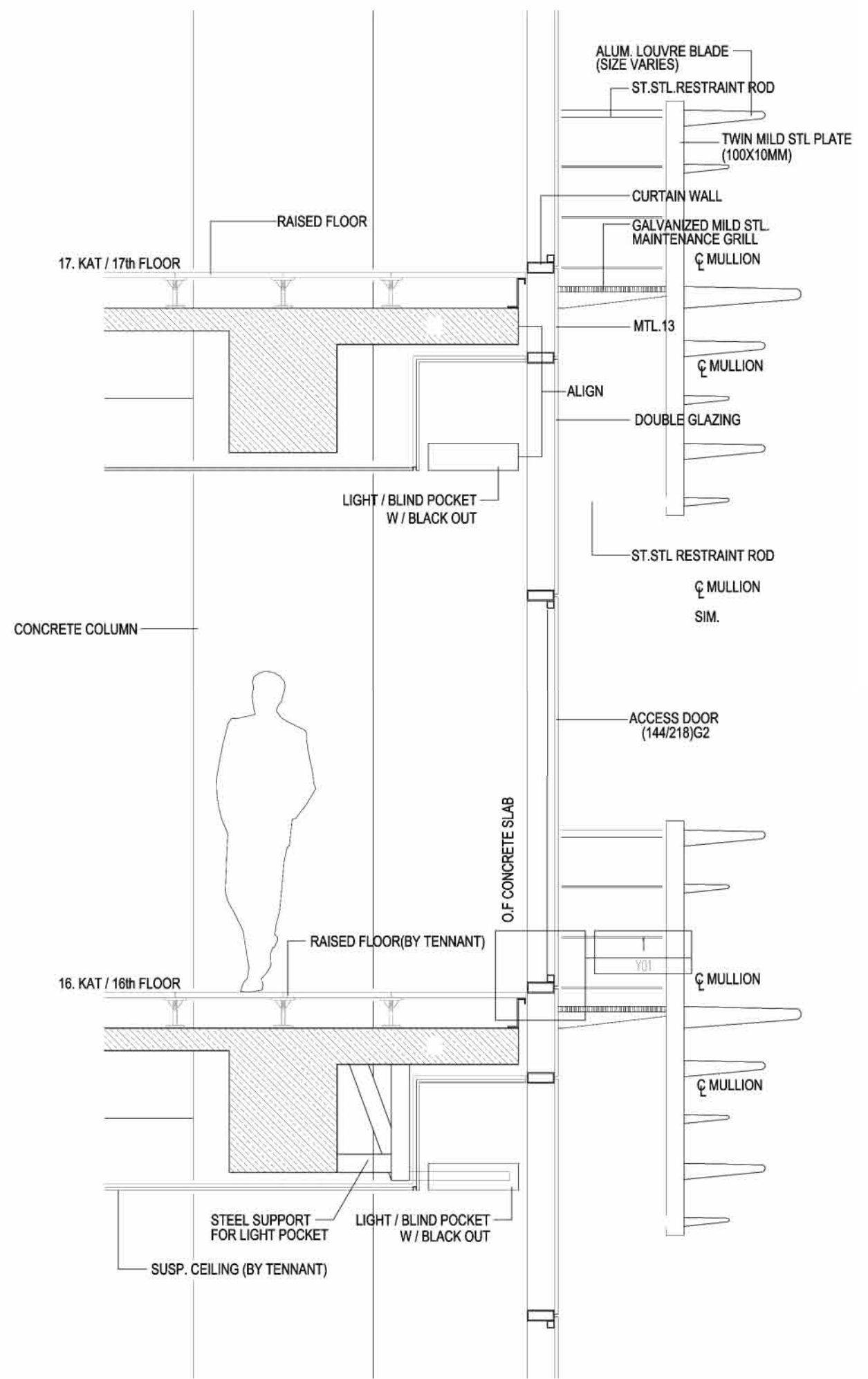



METROPOLIST

GIYDIRME  
CEPHE  
DÖŞEME  
BAĞLANTI

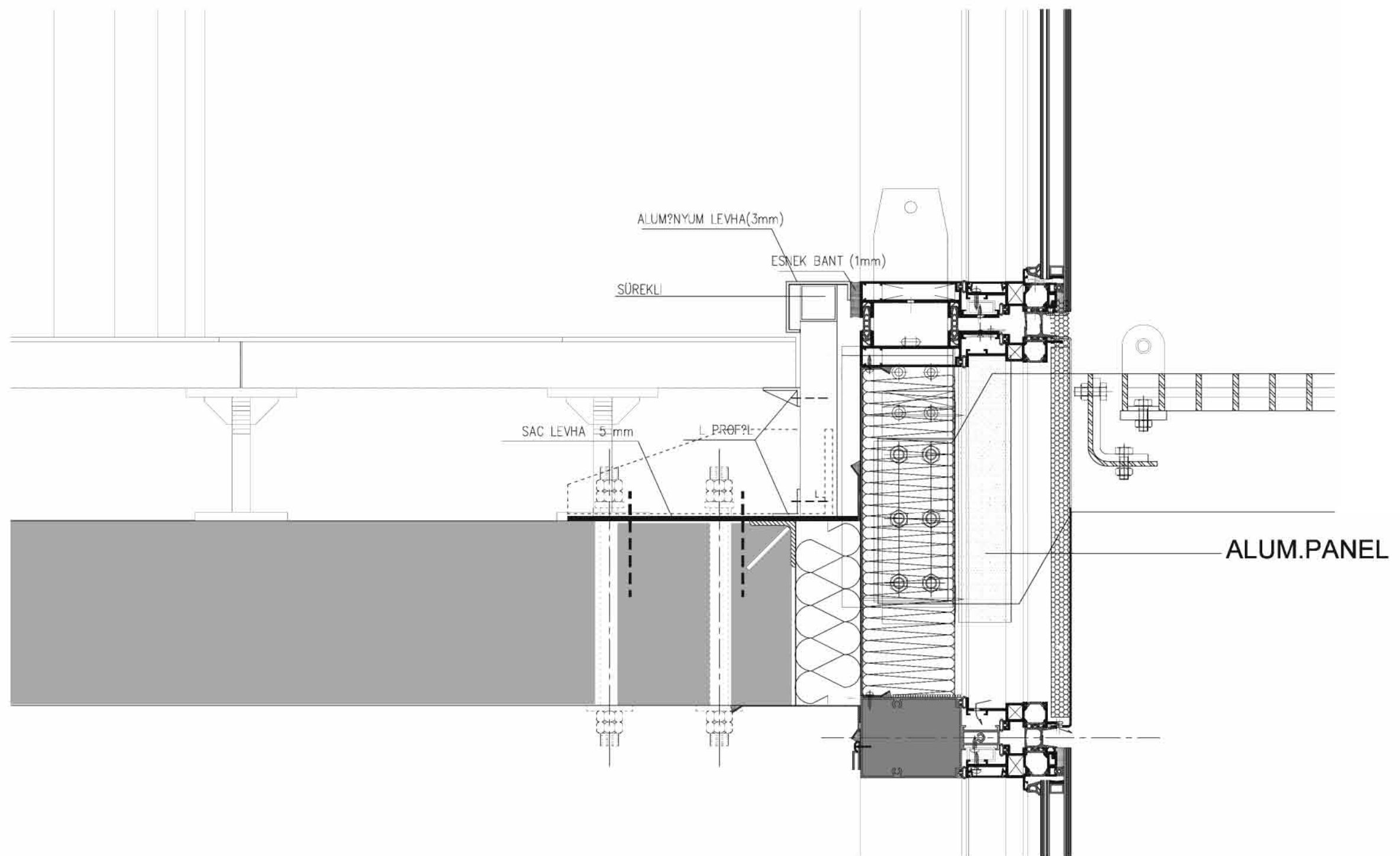

DORE  
ARCHITECTS



METROPOLIST

# HAVALANDIRMA ASMATAVAN DETAYI

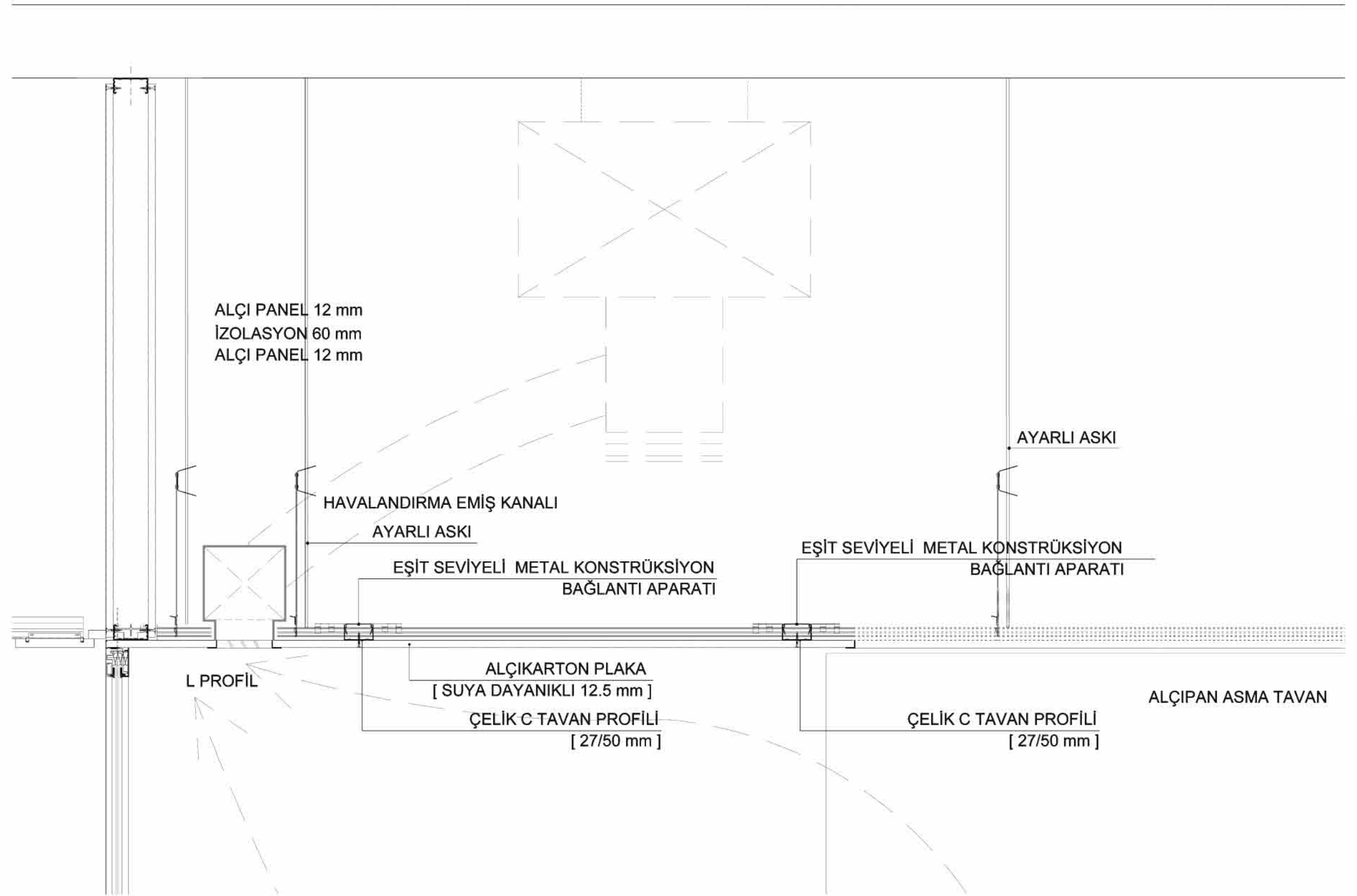



METROPOLIST

# YÜKSELTİLMİŞ DÖŞEME DETAYI

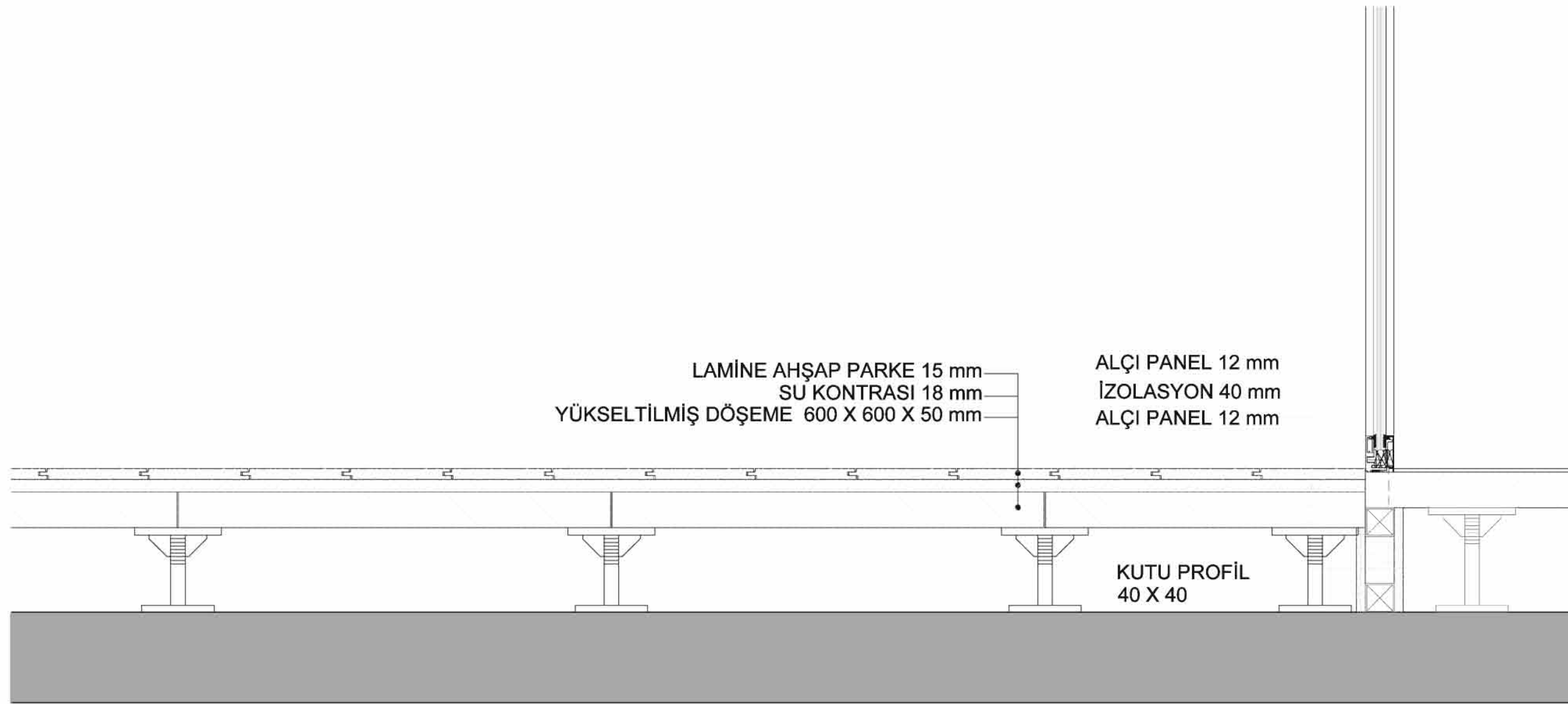



METROPOLIST

KEDİ YOLU  
PLAN DETAYI

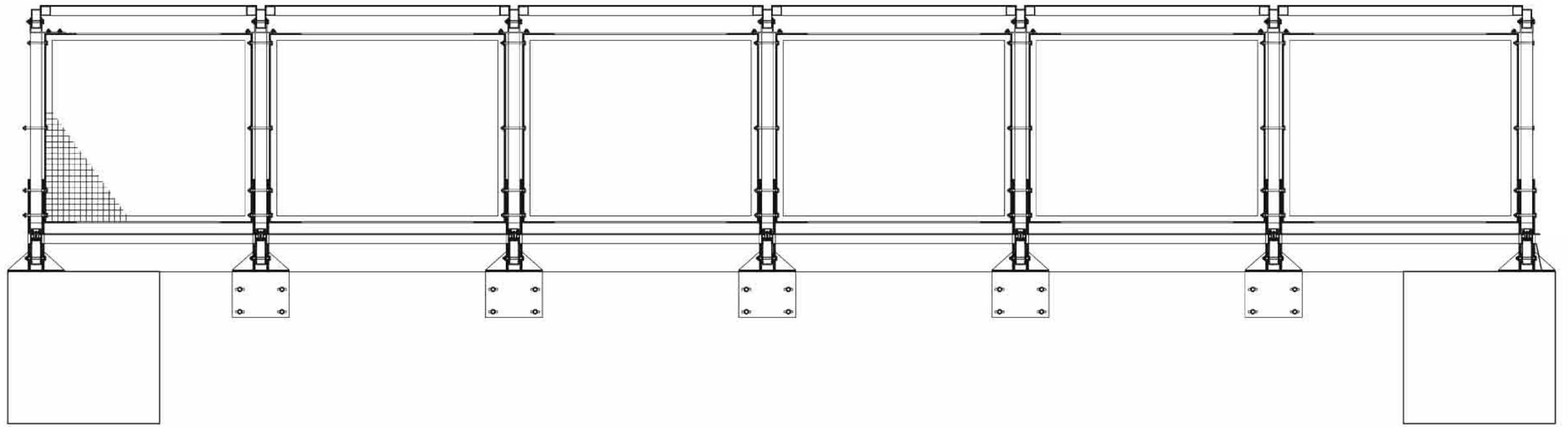

DORE  
ARCHITECTS



METROPOLIST

KEDİ YOLU  
KESİT  
DETAYI

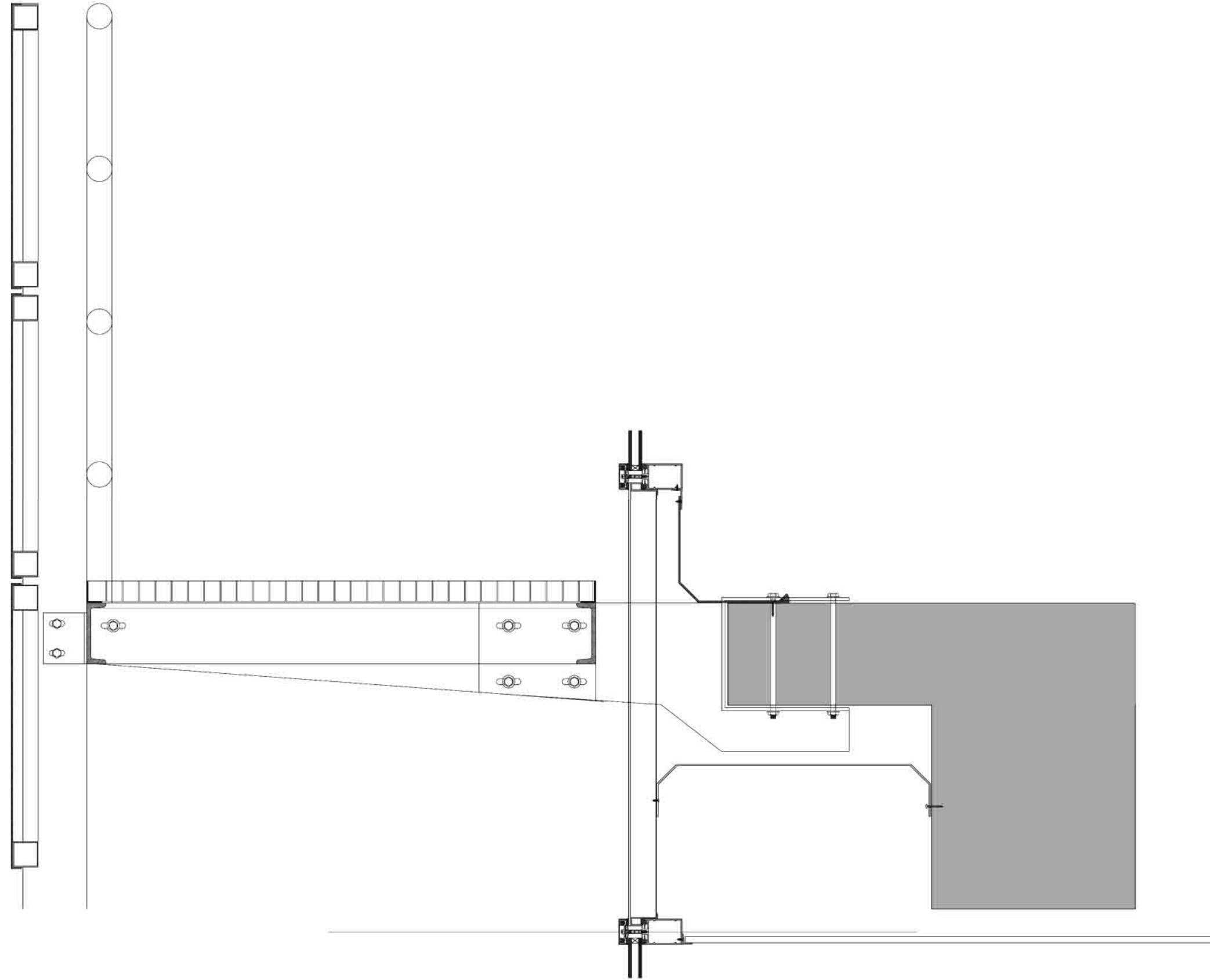

DORE  
ARCHITECTS





METROPOLIST

# KEDİ YOLU ANKRAJ DETAYI

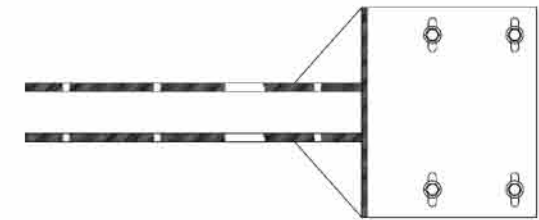
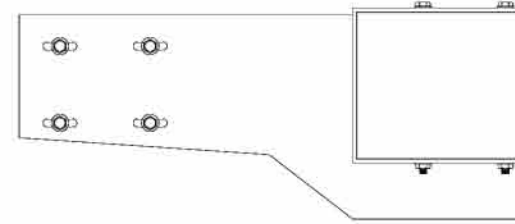
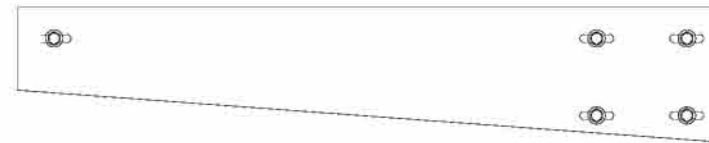
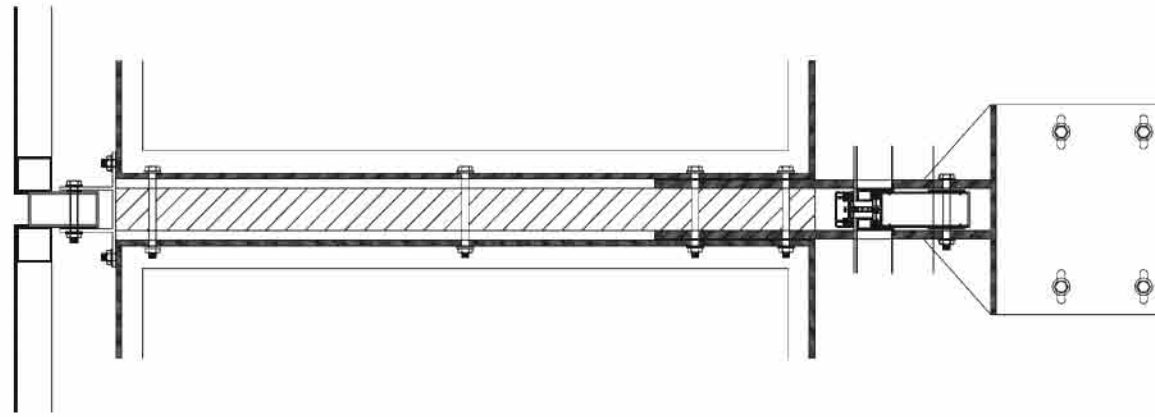



METROPOLIST

# KEDİ YOLU DETAYI

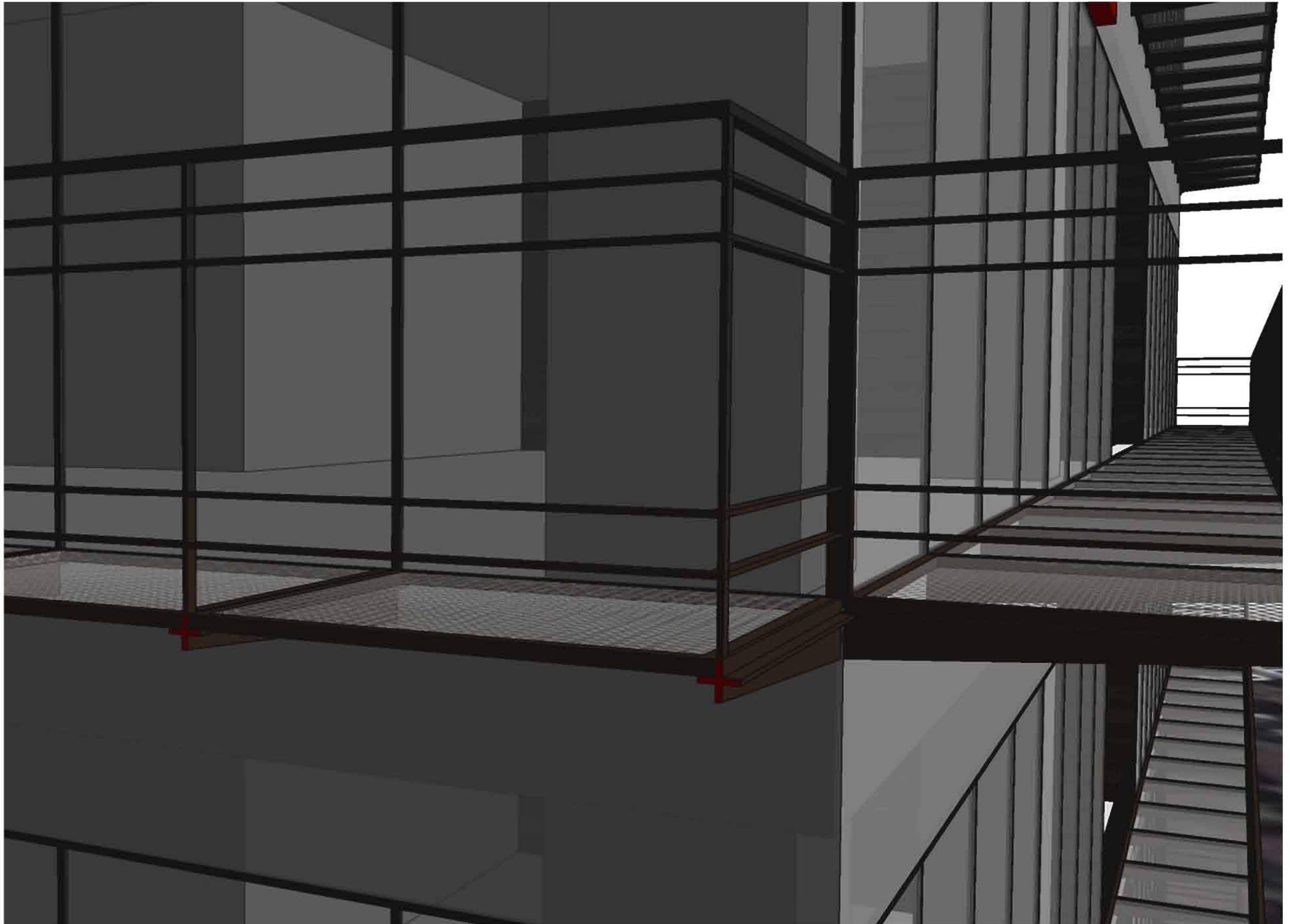



METROPOLIST

# KEDİ YOLU DETAYI

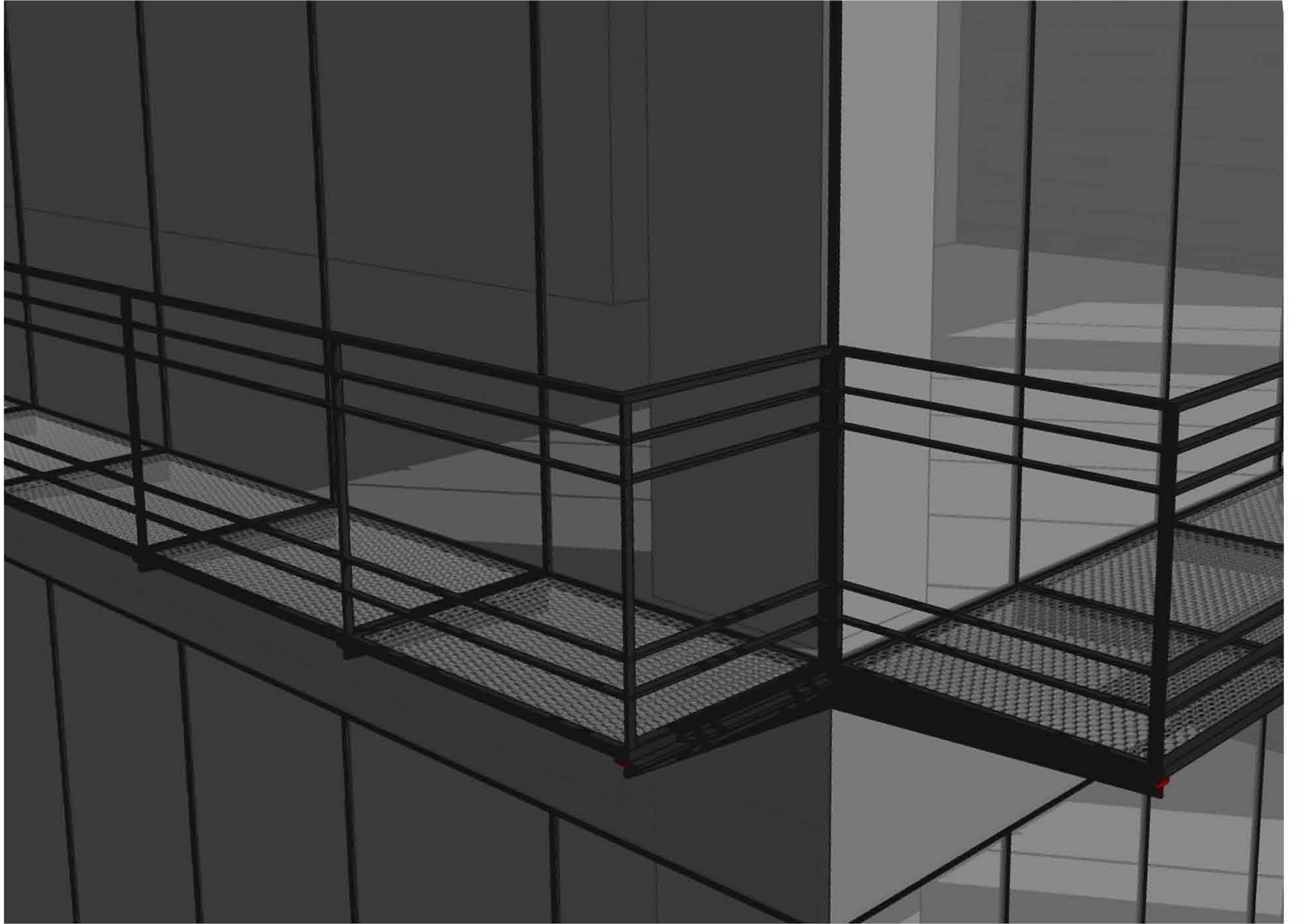



METROPOLIST

# CAM FRİT DETAYLARI

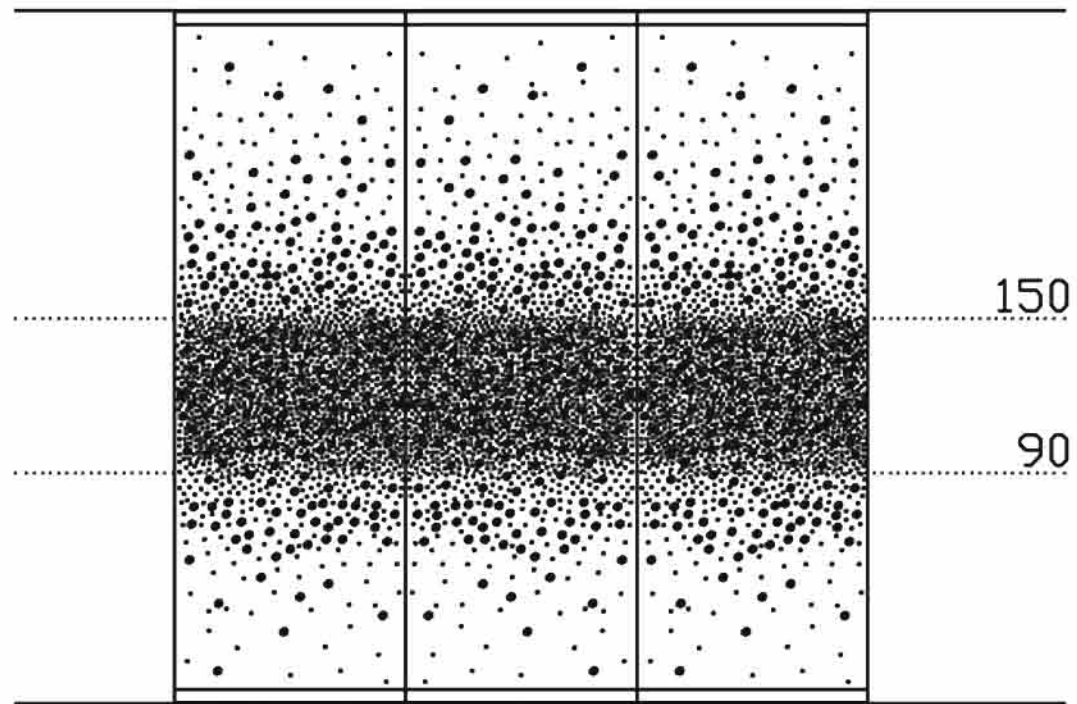

frit desen 1

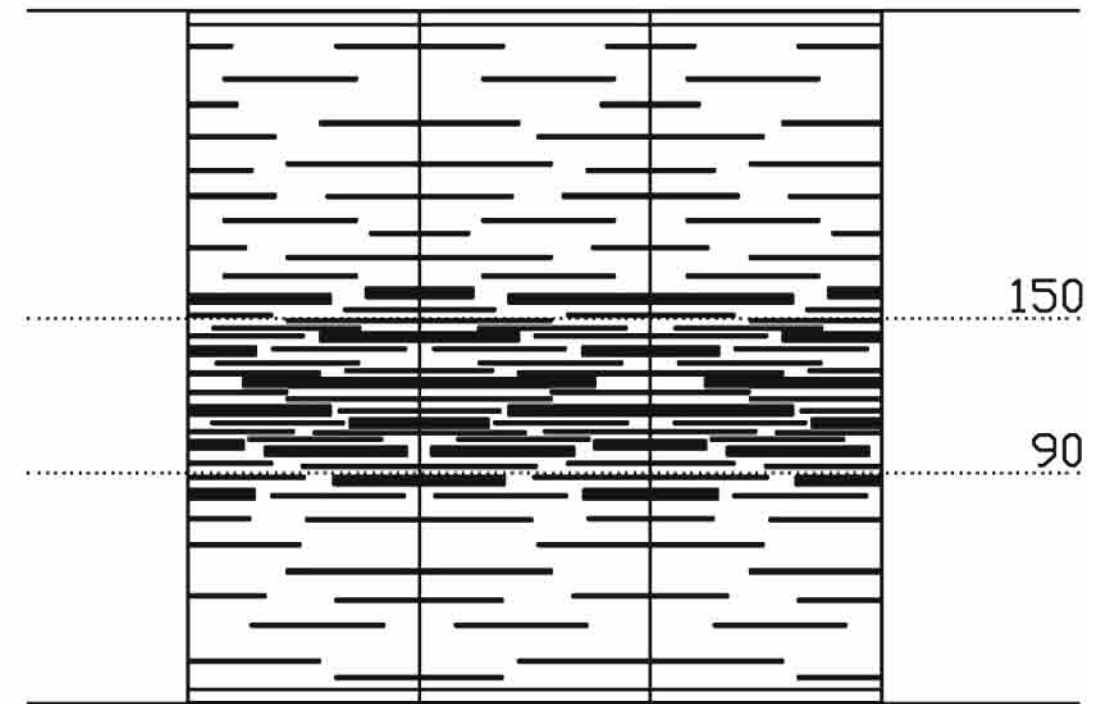

frit desen 11

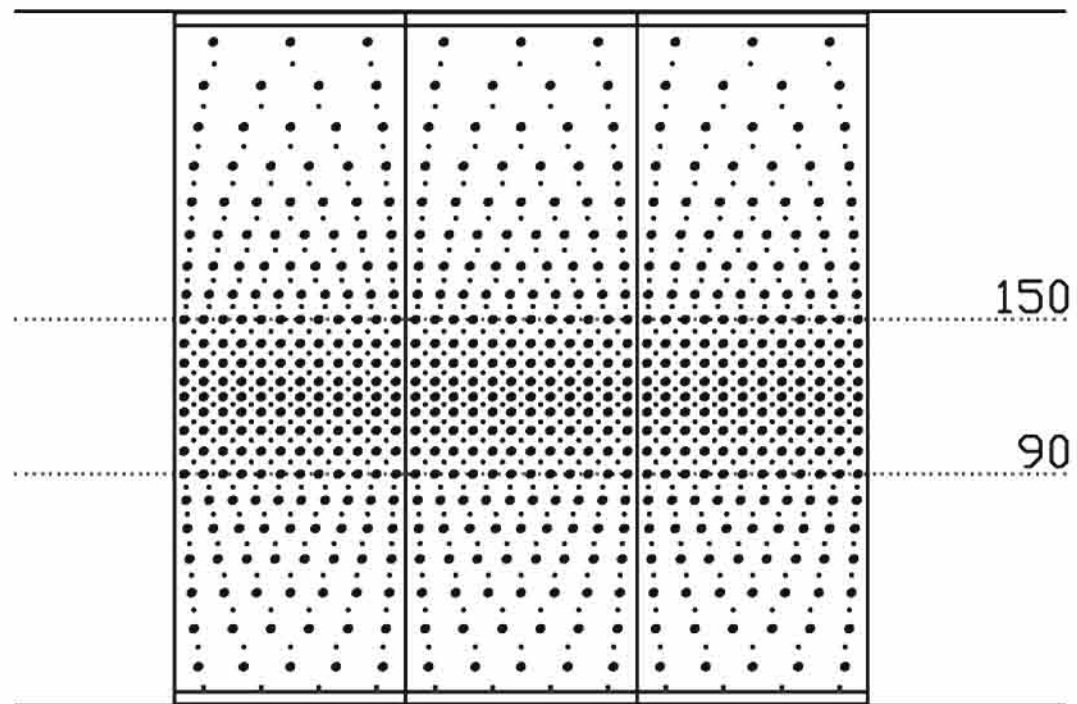

frit desen 3

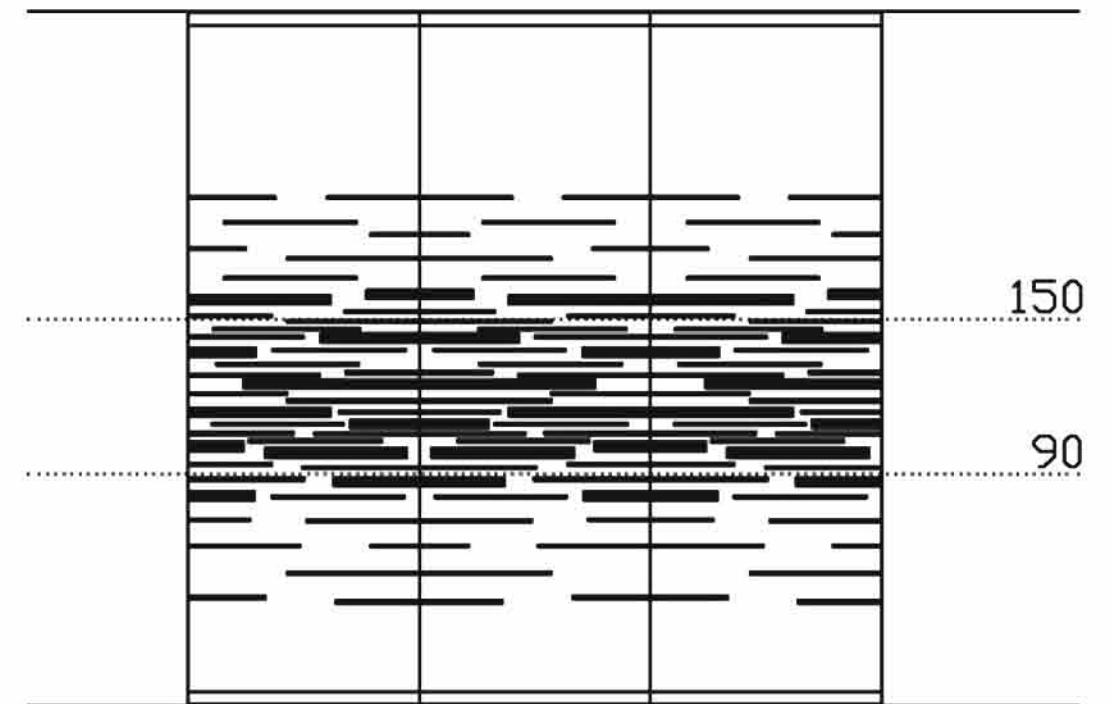

frit desen 11a

**DÖRE**  
**ARCHITECTS**

Cengiz Topel Sokak Meltem Apt. No:10/2 Kalamış 34726 Kadıköy / İSTANBUL  
www.doremimarlik.com T : 0216 449 37 44 F : 0216 449 26 23